

 **Berenson**™

**DECORATIVE
*HARDWARE***

Catalog 18



Featuring the Roque Collection

TABLE OF CONTENTS

NEW Collection

GENERAL INFORMATION

Simplicity	4
Online Ordering	6
QR Codes	8
Appliance Pulls	10
Additional Lines	13
Finish Guide	15
Installation Guide	110
Display Boards	112
Display Towers	123
Display Accessories	124
FAQ	126
Key to Codes	128
Part Number Index	129

CLASSIC COMFORT 17

Aspire	19
Brookridge	21
Connections	23
Designers' Group Ten	25
Dierdra	29
Domestic Bliss	33
Euro Moderno	35
Forté	36
Meadow	37
Oasis	39
Rivet Rebel	43
Subtle Surge	45
Tempo	47

UPTOWN APPEAL 51

Bravo	53
Elevate	55
Epoch Edge	57
Fluidic	59
Laura	63
Metro	67
Radial Reign	71
Roque	73
Skyline	75
Stainless Steel	77
Studio	78
Swagger	79

TIMELESS CHARM 81

American Classics	83
Andante	85
Echo	88
Euro Traditions	89
Harmony	90
Hearthstone	91
Hillcrest	93
Prelude	94
Tailored Traditional	97
Vested Interest	99
Vibrato	101
Village	103

ARTISAN INSPIRED 105

Art Nouveau	107
Rhapsody	108



WHAT'S NEW

We're bringing you new finishes, new lengths, and new collections!

Find all of our new products on the pages below or scan the QR code.

Brookridge	21
Dierdra	29
Domestic Bliss	33
Laura	63
Metro	67
Prelude	94
Radial Reign	71
Rivet Rebel	43
Roque	73
Swagger	79

Featuring the Radial Reign Collection
in Brushed Nickel and Matte Black
with 1in. Sample Clip



SAMPLICITY

Free Sample Program

Sample requests can be placed through our website, BerensonHardware.com,
by industry professionals who have a registered account.

Designers and dealers can request free samples for customers by email.

BENEFITS

We want to ensure that our customers are confident in their purchase with us which is why we make ordering samples simple and convenient. Through Sampilicity, our one of a kind sample program, we provide more samples than anyone else!

FREE SAMPLE CLIP

As a bonus, you can choose to receive a free sample clip with your order. This unique clip lets you preview how our hardware looks on your cabinet door or drawer without the commitment of drilling holes.

Choose between a 1in. clip, best for doors, or a 3in. clip, best for drawers.

NUMBER OF SAMPLES

Order up to 5 samples. Limit of 1 piece per style.

SHIPPING

Free samples also qualify for free shipping!
All samples are shipped via USPS mail.

You must have a mail receptacle to receive the package.

PRODUCTS INCLUDED

Berenson and Advantage Plus by Berenson knobs and pulls of 160mm CC or less.

PLEASE NOTE: Longer lengths and R. Christensen by Berenson hardware can be ordered as a sample at 50% off MSRP with paid flat rate shipping (\$4 per part). Hooks and appliance pulls are not available as samples.

Sample parts are not for display. Please contact us for display items and options.

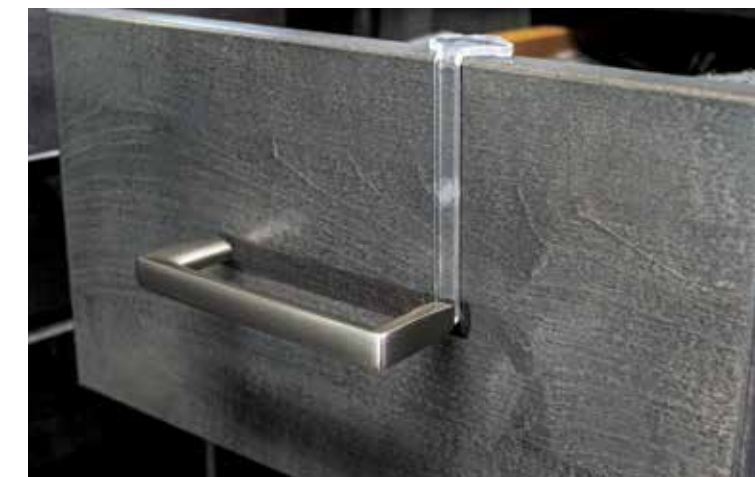

Featuring the Metro Collection in
Brushed Nickel with 3in. Sample Clip

3 EASY STEPS

1

Log in to your account at BerensonHardware.com.

Find the part you would like a sample of and click on its item number or description.

This will bring up the Item Detail page and the **Request A Sample** button.

2

A window will pop up requesting **shipping info** and credit card info, if the sample requires a payment.

3

After you fill in the required information, click **Submit Sample Request** and your request will be processed.



ONLINE ORDERING

Gain Access to Account Tools & More!

Anyone with a Berenson customer account is eligible for online ordering through our website, BerensonHardware.com.

Featuring the Hearthstone Collection in Matte Black

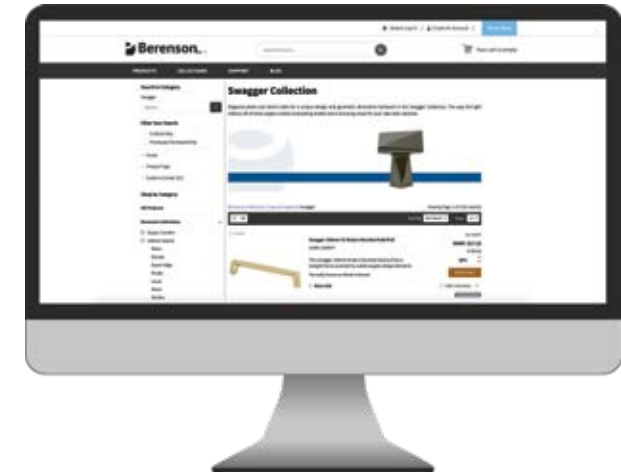

3 EASY STEPS

1

CREATE ACCOUNT

Scan the QR code at the top of the page to be taken to our create account page. Enter your name and email address.

2

APPROVAL PROCESS

Check your email for a message from Web@BerensonHardware.com. This will include a link to fill out your business information.

If you don't see a verification email in your inbox, be sure to check your junk mail and add the email address above to your safe sender's list.

Once approved, you'll receive an email to log in to your account.

3

ORDER ONLINE

Use your web account to place orders at any time! You can also access various account tools to help you stay in the know about your Berenson orders.

- Order Tracking
- Recent Orders
- Invoices
- Backorders

FIND A STORE

Customers can use our [Find a Store](#) page to search for the closest showroom or distributor offering our hardware.

Just enter your zip code or address to see a full list of nearby stores with Berenson product.

DON'T BUY DIRECT?

Industry professionals can still sign up for a web account, giving you access to product availability, favorites lists, and up to **5 free samples!**

For more information, contact:

Sales@BerensonHardware.com | 800.333.0578

Featuring the Brookridge Collection
in Brushed Nickel



QR CODES

Instant Access to Up to Date Information

Berenson is using QR codes on cabinet hardware display boards and catalogs, connecting customers with our website and instant access to up-to-date information.



QR codes can be scanned using an online QR code scanner or app on a smartphone or tablet. *(Please note the camera on some smartphones can also read QR codes).*

You can find QR codes throughout this catalog. Scanning them will bring you to pages on our website with additional information on the subject featured.

QR codes on our display boards will bring up a convenient-to-use page on our website, with **parts from the collection(s) featured on the board grouped by CC length**. This page is just a click away and offers information on all parts in the collection, including those not on the display board.

QR Code stickers are available for your existing Berenson boards. **Our sticker sheet, 0175-STKR-01**, contains a sticker for every Berenson board labeled with the collection name and display board part number for your convenience.

Order yours today by emailing
Orders@BerensonHardware.com



MOBILE
PREVIEW

OF ALL LENGTHS,
FINISHES, AND
PART NUMBERS!



BERENSON
DISPLAY
BOARD QR
CODE STICKER
SHEET

0175-STKR-01

Featuring the Brookridge Collection
in Brushed Nickel



APPLIANCE PULLS

What are they and how can you
incorporate them into your space?

These pulls are longer and wider cabinet pulls,
designed to handle what regular hardware cannot.

BENEFITS

Appliance pulls are the key to tying your kitchen together with a harmonious appearance. These pulls are longer and wider cabinet pulls, designed to handle what regular hardware cannot.

They are a convenient choice for tall pantry doors or heavy and wide storage drawers that would otherwise need multiple knobs or pulls. Use them on appliances such as ovens and dishwashers to match the hardware of your cabinets for a streamlined design.

All of our appliance pulls have a 10-24 tap for a strong and secure fit.

Sizes include 256mm CC, 12in. CC, 320mm CC, 448mm CC, and 18in. CC.

COLLECTIONS

The following collections feature an appliance pull option.

Aspire	pg 19
Brookridge*	pg 21
Designers' Group Ten	pg 25
Dierdra*	pg 29
Domestic Bliss*	pg 33
Elevate	pg 55
Epoch Edge	pg 57
Forté	pg 36
Hearthstone	pg 91
Hillcrest	pg 93
Laura*	pg 63
Meadow	pg 37
Metro	pg 67
Radial Reign*	pg 71
Rivet Rebel*	pg 43
Roque*	pg 73
Subtle Surge	pg 45
Swagger*	pg 79
Tailored Traditional	pg 97
Vested Interest	pg 99
Village	pg 103

***NEW**

MERCHANDISING

Our showroom presentation option includes our Appliance Pull display board.

Featured on this board in trending finishes, are our longest appliance pulls from some of our most popular collections.

There will be an additional Appliance Pull display board launching spring 2024.



Appliance Pull Premium Display Board 01

0520-6000-03



See a few of our
appliance pulls
true to scale on
the next page.



APPLIANCE PULLS

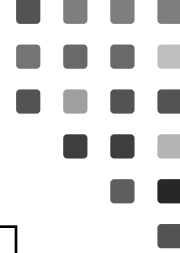

Shown to Scale



256mm CC • *Hillcrest Featured in Brushed Nickel*



12in. CC • *Laura Featured in Modern Brushed Gold*



12in. CC • *Radial Reign Featured in Slate*



320mm CC • *Elevate Featured in Graphite*

Appliance pulls come with (2) 10-24 x 1in. machine screws, shown to scale.

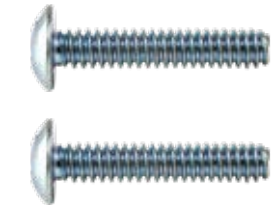

Scan the QR Code to the left to view our **Appliance Pull Supplement** to see our full offering of appliance pulls.

ADDITIONAL LINES

For information on our additional lines,
please contact Sales or scan the QR codes.

Sales@BerensonHardware.com | 800.333.0578



Featuring the Transitional Advantage
Two Collection in Matte Black
Design and photos by Jennifer Hutton at
Artisan Kitchens and Baths, @JenniferHutton_Pro



VALUE
Advantage
+Plus by
Berenson.



HIGH-END
R. Christensen
by Berenson.

DETAILS

Advantage Plus by Berenson ensures everyone can complete the design of their beautiful home by offering cabinet hardware at an **affordable price**.

The collections included come in popular and trending finishes: Brushed Nickel, Champagne, Matte Black, Polished Chrome, Verona Bronze, and Weathered Nickel. Coming in a variety of stylish designs including edge pulls and cup pulls, there is something here for everyone.

The 12 value collections featured in this line come in three styles: **contemporary, traditional, and transitional**.

Our assortment of wire pulls can also be found here in Advantage Wire Pulls. They come in a variety of popular finishes as well as four common sizes: 3in., 3 1/2in., 96mm and 4in.



Display boards measure: 11 1/4in. x 15 1/4in. x 1/2in.

DISPLAY DETAILS

Our Advantage Plus by Berenson display boards are blue in color.

The price code, center to center measurement and part number can be found listed below each part on the display board.

There are **12 boards in the Advantage Plus line**, one for each collection.

DETAILS

The decorative hardware of R. Christensen by Berenson is crafted to complement the sleek appearance of **contemporary** spaces.

This line includes the Art Tech series, featuring knobs and pulls with clean lines and **smooth surfaces**, that add sophisticated beauty to **minimalist designs**.

Their subtle beauty elevates kitchen and baths to the next level and are available in trending finishes such as Soft Gold and Charcoal Gray, as well popular finishes such as Brushed Nickel and Polished Chrome.

These collections feature a variety of hardware types including edge pulls, drop pulls, hooks and recess pulls. Designs are bold and add an updated take to classic styles.



Display boards measure: 11 1/4in. x 15 1/4in. x 1/2in.

DISPLAY DETAILS

Our R. Christensen by Berenson display boards are white in color.

A selection of favorite Art Tech collections have been paired together to be featured on 8 stylish display boards.

These boards do not feature item numbers on the front and include recent additions such as Fluid, Mini, and our new finish, Rose Gold.



FINISH GUIDE

Quickly reference Berenson finishes with the finish selection board.
Match our finishes to your projects with a convenient display board. Find it on page 121.

Berenson's Most Popular Finishes:



55 Black / Matte Black / Satin Black



BPN Brushed Nickel



MDB Modern Brushed Gold



26 Polished Chrome



VB Verona Bronze



VTN Vintage Nickel



Aluminum
ALU

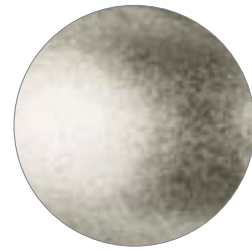

Antique Pewter
AP



Black / Matte Black / Satin Black
55



Matte Black and Brushed Nickel
55BPN

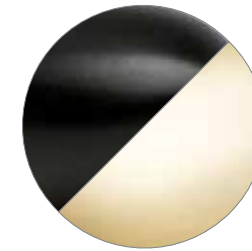

Matte Black and Modern Brushed Gold
55MDB

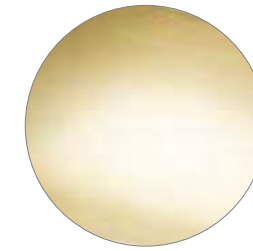

Modern Brushed Gold
MDB



Oil Rubbed Bronze
ORB

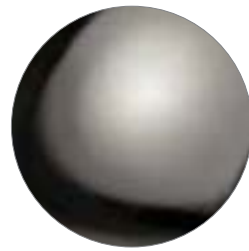

Black Nickel
98

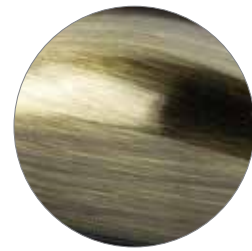

Brushed Antique Brass
BAB

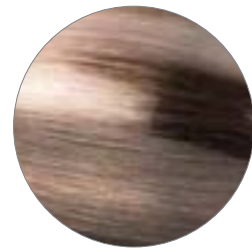

Brushed Antique Copper
BAC

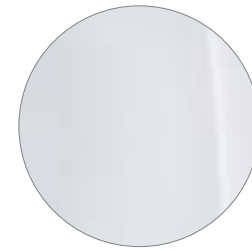

Polished Chrome
26

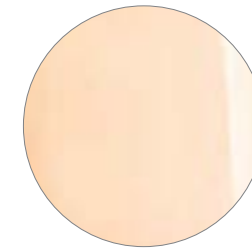

Polished Copper
PC



Polished Nickel
14

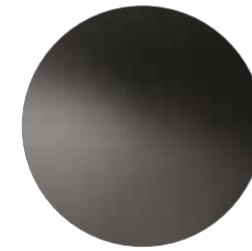

Rubbed Bronze
10

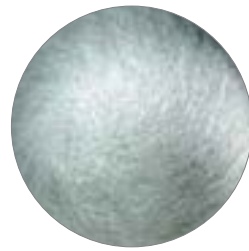

Brushed Antique Pewter
BAP

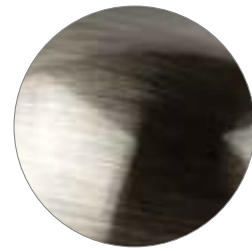

Brushed Black Nickel
BBN

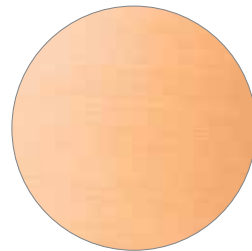

Brushed Copper
BC

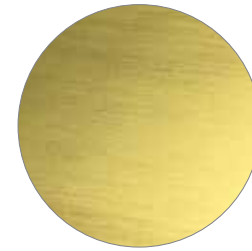

Satin Gold
SG

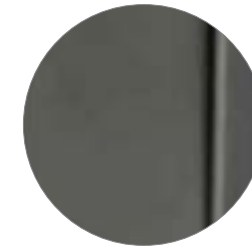

Slate
SLT

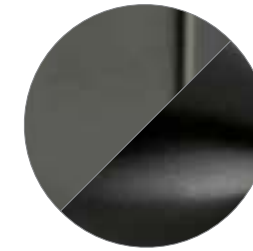

Slate and Matte Black
SLT55



Stainless Steel
SS

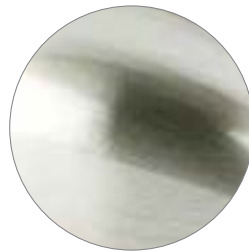

Brushed Nickel
BPN



Brushed Nickel and Matte Black
BPN55



Brushed Tin
BT



Toasted Bronze
TB



Verona Bronze
VB

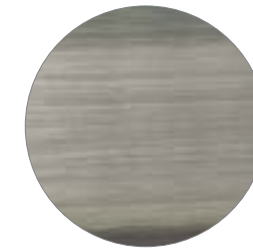

Vintage Nickel
VTN



Weathered Copper
WC

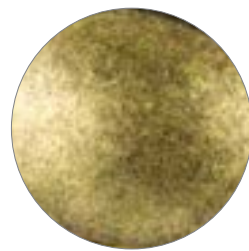

Dull Bronze
DBZ



Dull Rust
FE



Graphite
GPH

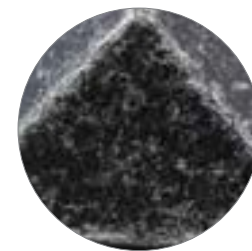

Weathered Iron
LWI



Weathered Nickel
WN



Weathered Verona Bronze
WVB



Featuring the Brookridge Collection
in Polished Chrome

CLASSIC *COMFORT*

Transitional Style

Effortlessly blend elements like modern, soft curves into
time-honored hardware designs & achieve transitional bliss.



ASPIRE

CLASSIC COMFORT - Transitional Style

Collection Featured in Brushed Tin



**Appliance Pull
Also Available**

12in. CC

160mm CC

128mm CC

96mm CC

Knob
has tooth at bottom to
help secure in position

Aspire Product Data

Collection Material: Zinc

CC	Product Type	Length	Width	Height/ Projection	Hand Clearance	Diameter	Base	Tap/Screws (Qty)
*18in.	Appliance Pull	18 3/8in.	1 1/2in.	1 1/4in.	1 3/8in.	-	1/2in.	10-24 x 1in. (2)
12in.	Appliance Pull	12 7/16in.	1in.	1 1/4in.	1 1/4in.	-	7/16in.	10-24 x 1in. (2)
160mm	Pull	6 1/2in.	1 1/16in.	1 1/4in.	1 5/16in.	-	5/16in.	8-32 x 1in. (2)
128mm	Pull	5 7/16in.	1 1/16in.	1 1/4in.	1 5/16in.	-	5/16in.	8-32 x 1in. (2)
96mm	Pull	4 1/8in.	1 1/16in.	1 1/4in.	1 3/8in.	-	5/16in.	8-32 x 1in. (2)
-	Knob	1 1/4in.	3/4in.	1 3/8in.	6 1/4in.	-	1 1/16in.	8-32 x 1in. (1)

*Product not shown, please visit BerensonHardware.com to view images and details.

Aspire Available Finishes, Sizes & Part Numbers

Handle Underside: Flat



BRUSHED COPPER

18in. CC	Not Available
12in. CC	2145-10BC-P
160mm CC	2144-10BC-P
128mm CC	2143-10BC-P
96mm CC	2142-10BC-P
Knob	2146-10BC-P

BRUSHED NICKEL

18in. CC	2148-1BPN-P
12in. CC	9240-1BPN-P
160mm CC	9237-1BPN-P
128mm CC	9234-1BPN-P
96mm CC	9231-1BPN-P
Knob	9243-1BPN-P

BRUSHED TIN

18in. CC	2149-10BT-P
12in. CC	9241-10BT-P
160mm CC	9238-10BT-P
128mm CC	9235-10BT-P
96mm CC	9232-10BT-P
Knob	9244-10BT-P

MATTE BLACK

18in. CC	2140-1055-P
12in. CC	2139-1055-P
160mm CC	2138-1055-P
128mm CC	2137-1055-P
96mm CC	2136-1055-P
Knob	2141-1055-P



MODERN BRUSHED GOLD

18in. CC	2134-1MDB-P
12in. CC	2133-1MDB-P
160mm CC	2132-1MDB-P
128mm CC	2131-1MDB-P
96mm CC	2130-1MDB-P
Knob	2135-1MDB-P



POLISHED CHROME

18in. CC	2147-1026-P
12in. CC	9239-1026-P
160mm CC	9236-1026-P
128mm CC	9233-1026-P
96mm CC	9230-1026-P
Knob	9242-1026-P



VERONA BRONZE

18in. CC	2150-10VB-P
12in. CC	2032-10VB-P
160mm CC	2031-10VB-P
128mm CC	2030-10VB-P
96mm CC	2029-10VB-P
Knob	2033-10VB-P

BROOKRIDGE

CLASSIC COMFORT - *Transitional Style*

Collection Featured in Verona Bronze

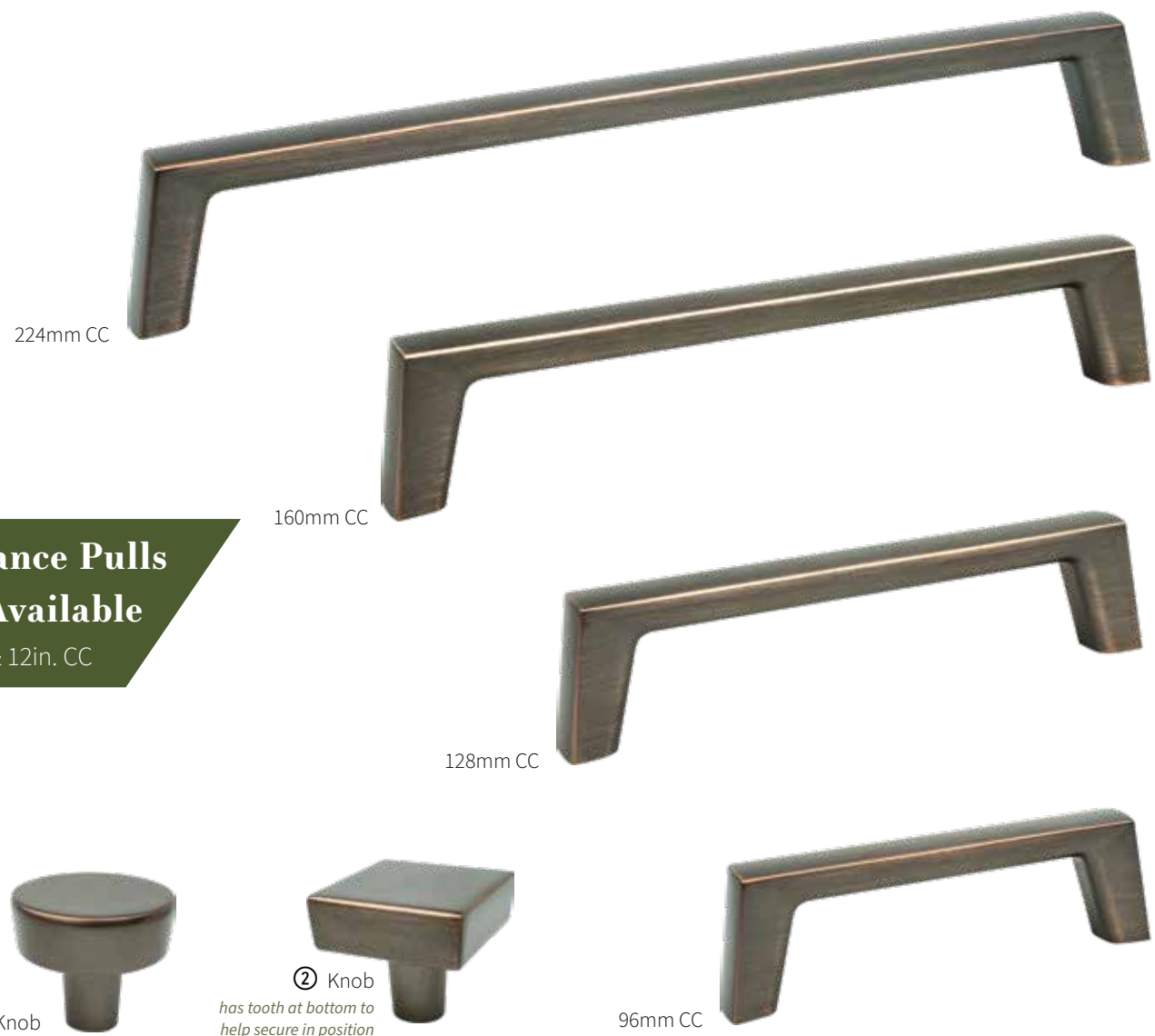

Appliance Pulls
Also Available

18in. CC & 12in. CC

Brookridge Product Data

Collection Material: Zinc

CC	Product Type	Length	Width	Height/ Projection	Hand Clearance	Diameter	Base	Tap/Screws (Qty)
*18in.	Appliance Pull	18 2 ⁵ / ₁₆ in.	1 ⁵ / ₁₆ in.	2in.	1 1/2in.	-	2 ³ / ₁₆ in.	10-24 x 1in. (2)
*12in.	Appliance Pull	12 3/4in.	2 ⁷ / ₃₂ in.	1 3/4in.	1 2 ¹ / ₄ in.	-	1 ⁹ / ₃₂ in.	10-24 x 1in. (2)
224mm	Pull	9 1 ¹ / ₂ in.	1 ¹ / ₁₆ in.	1 3/8in.	1 1/2in.	-	1 ⁵ / ₃₂ in.	8-32 x 1in. (2)
160mm	Pull	6 1 ¹ / ₁₆ in.	1 ⁵ / ₃₂ in.	1 1/4in.	3 ¹ / ₃₂ in.	-	1/2in.	8-32 x 1in. (2)
128mm	Pull	5 7/16in.	1 ⁵ / ₃₂ in.	1 1/4in.	3 ¹ / ₃₂ in.	-	1/2in.	8-32 x 1in. (2)
96mm	Pull	4 3/16in.	1 ⁵ / ₃₂ in.	1 1/4in.	3 ¹ / ₃₂ in.	-	1/2in.	8-32 x 1in. (2)
-	⓪ Knob	-	-	1 7/32in.	2 ³ / ₃₂ in.	1 1/2in.	1/2in.	8-32 x 1in. (1)
-	Ⓛ Knob	1 3/16in.	1 3/16in.	1 7/32in.	3/4in.	-	1/2in.	8-32 x 1in. (1)

*Product not shown, please visit BerensonHardware.com to view images and details.

21 | CC = center to center | images of parts are not shown at 100% scale

Brookridge Available Finishes, Sizes & Part Numbers

Handle Underside: Semi-Curved

NEW
18in. CC Length
coming spring 2024



BRUSHED NICKEL

■ 18in. CC	2657-1BPN-P
■ 12in. CC	2635-1BPN-P
■ 224mm CC	2630-1BPN-P
■ 160mm CC	2625-1BPN-P
■ 128mm CC	2620-1BPN-P
■ 96mm CC	2615-1BPN-P
⓪ Knob	2640-1BPN-P
Ⓛ Knob	2645-1BPN-P



MATTE BLACK

■ 18in. CC	2658-1055-P
■ 12in. CC	2636-1055-P
■ 224mm CC	2631-1055-P
■ 160mm CC	2626-1055-P
■ 128mm CC	2621-1055-P
■ 96mm CC	2616-1055-P
⓪ Knob	2641-1055-P
Ⓛ Knob	2646-1055-P



MODERN BRUSHED GOLD

■ 18in. CC	2659-1MDB-P
■ 12in. CC	2639-1MDB-P
■ 224mm CC	2634-1MDB-P
■ 160mm CC	2629-1MDB-P
■ 128mm CC	2624-1MDB-P
■ 96mm CC	2619-1MDB-P
⓪ Knob	2644-1MDB-P
Ⓛ Knob	2649-1MDB-P



POLISHED CHROME

■ 18in. CC	Not Available
■ 12in. CC	2654-1026-P
■ 224mm CC	2653-1026-P
■ 160mm CC	2652-1026-P
■ 128mm CC	2651-1026-P
■ 96mm CC	2650-1026-P
⓪ Knob	2655-1026-P
Ⓛ Knob	2656-1026-P



VERONA BRONZE

■ 18in. CC	Not Available
■ 12in. CC	2637-10VB-P
■ 224mm CC	2632-10VB-P
■ 160mm CC	2627-10VB-P
■ 128mm CC	2622-10VB-P
■ 96mm CC	2617-10VB-P
⓪ Knob	2642-10VB-P
Ⓛ Knob	2647-10VB-P

CONNECTIONS

CLASSIC COMFORT - *Transitional Style*

Collection Featured in Verona Bronze



160mm CC



96mm CC



3in. CC



Knob
has tooth at bottom to help secure in position

Connections Available Finishes, Sizes & Part Numbers

Handle Underside: Curved



MATTE BLACK

160mm CC 4005-1055-P

96mm CC 4131-1055-P

3in. CC 4002-1055-P

Knob 4008-1055-P



VERONA BRONZE

160mm CC 4006-10VB-P

96mm CC 4132-10VB-P

3in. CC 4003-10VB-P

Knob 4009-10VB-P



VINTAGE NICKEL

160mm CC 4004-1VTN-P

96mm CC 4130-1VTN-P

3in. CC 4001-1VTN-P

Knob 4007-1VTN-P

Connections Product Data

Collection Material: Zinc

CC	Product Type	Length	Width	Height/Projection	Hand Clearance	Diameter	Base	Tap/Screws (Qty)
160mm	Pull	6 7/8in.	9/16in.	1 1/4in.	2 9/32in.	-	3/8in.	8-32 x 1in. (2)
96mm	Pull	4 3/4in.	1/2in.	1 1/4in.	2 9/32in.	-	3/8in.	8-32 x 1in. (2)
3in.	Pull	3 1/2in.	1/2in.	1 1/4in.	2 7/32in.	-	3/8in.	8-32 x 1in. (2)
-	Knob	1 1/4in.	1 1/8in.	1 1/4in.	-	-	3/8in.	8-32 x 1in. (1)

A powerful presence expands out to elegant surface details.



DESIGNERS' GROUP TEN

CLASSIC COMFORT - *Transitional Style*

Collection Only Available in Polished Nickel



① 160mm CC
semi-curved underside

② 128mm CC
semi-curved underside

③ 3in. CC
semi-curved underside



④ **6in. CC
semi-curved underside

⑥ 96mm CC
curved underside

⑤ 96mm CC
semi-curved underside

⑧ Knob

⑨ Knob
has tooth at bottom to help hold in position

⑦ 96mm CC
curved underside

⑩ Knob

⑪ **6in. CC
curved underside

⑫ 4in. CC
curved underside

⑭ Knob

⑮ Knob

⑬ 3in. CC
curved underside

⑯ 3in. CC
curved underside



Appliance Pulls
Also Available

18in. CC & 12in. CC

Designers' Group Ten Product Data

Collection Material: Zinc

	Part No.	CC	Product Type	Length	Width	Height/ Projection	Hand Clearance	Diameter	Base	Tap/Screws (Qty)
	4154-1014-P	*18in.	Appliance Pull	19 1/4in.	1 1/16in.	1 5/16in.	1 3/8in.	-	1 3/16in.	10-24 x 1in. (2)
	2036-1014-P	*12in.	Appliance Pull	13 3/4in.	3/4in.	1 13/16in.	1 23/64in.	-	1 1/16in.	10-24 x 1in. (2)
1	2046-1014-P	160mm	Pull	7 5/8in.	9/16in.	1 1/2in.	1 23/64in.	-	7/8in.	8-32 x 1in. (2)
2	+2041-1014-P	128mm	Pull	6 1/8in.	1/2in.	1 7/16in.	1 1/6in.	-	7/8in.	8-32 x 1in. (2)
3	4139-1014-P	3in.	Pull	3 1/8in.	3/8in.	1 3/8in.	63/64in.	-	13/16in.	8-32 x 1in. (2)
4	4141-1014-P	**6in.	Pull	7 3/8in.	1 1/16in.	1 1 1/16in.	1 5/32in.	-	1 1/8in.	8-32 x 1in. (2)
5	+4140-1014-P	96mm	Pull	4 1 3/16in.	3/8in.	1 3/8in.	63/64in.	-	7/8in.	8-32 x 1in. (2)
6	4153-1014-P	96mm	Pull	4 3/8in.	1/2in.	1 3/8in.	3/4in.	-	9/16in.	8-32 x 1in. (2)
7	4144-1014-P	96mm	Pull	5 1/4in.	5/8in.	1 9/16in.	23/32in.	-	7/8in.	8-32 x 1in. (2)
8	4145-1014-P	-	Knob	-	-	1 5/16in.	1 1/16in.	1 3/4in.	1in.	8-32 x 1in. (1)
9	4142-1014-P	-	Knob	1 9/16in.	1 1/8in.	1 1/8in.	3/4in.	-	13/16in.	8-32 x 1in. (1)
10	4143-1014-P	-	Knob	-	-	1 1/16in.	-	1 1/8in.	1 1/16in.	8-32 x 1in. (1)
11	4149-1014-P	**6in.	Pull	6 5/8in.	1 1/16in.	1 7/8in.	1 7/32in.	-	9/16in.	8-32 x 1in. (2)
12	4147-1014-P	4in.	Pull	4 3/8in.	1/2in.	1 1/4in.	51/64in.	-	3/8in.	8-32 x 1in. (2)
13	4148-1014-P	3in.	Pull	3 1/2in.	1/2in.	1 3/8in.	51/64in.	-	3/8in.	8-32 x 1in. (2)
14	4150-1014-P	-	Knob	-	-	1 5/16in.	-	1 1/4in.	1 1/16in.	8-32 x 1in. (1)
15	4152-1014-P	-	Knob	-	-	1 1/8in.	-	1 3/8in.	1 1/8in.	8-32 x 1in. (1)
16	4146-1014-P	3in.	Cup Pull	4 1 1/8in.	1 1/16in.	1 1/8in.	53/64in.	-	-	8-32 x 1in. (2)

*Product not shown, please visit BerensonHardware.com to view images and details.

**The 6in. CC pulls feature a wider width that adds dimension to kitchen and bath designs.

+2 Additional 8-32 x 1 3/4in.
break-off screws provided.

Some parts in this collection can
be found in additional finishes
from our other collections.

①-⑤, ⑨ & Appliance Pulls • Hearthstone - p. 91

⑧ • Andante - p. 85

⑪-⑭ • Forté - p. 36

⑦, ⑩ • Euro Moderno - p. 35

⑯ • American Classics - p. 83



Featuring the Dierdra Collection
in Matte Black

DIERDRA

CLASSIC COMFORT - Transitional Style

Collection Featured in Toasted Bronze



Appliance Pull
Also Available

12in. CC

Dierdra Product Data

Collection Material: Zinc

CC	Product Type	Length	Width	Height/Projection	Hand Clearance	Diameter	Base	Tap/Screws (Qty)
■ *12in.	Appliance Pull	13 ¼in.	7/8in.	1 2½in.	1 1/16in.	-	5/8in.	10-24 x 1in. (2)
224mm	Pull	9 ½in.	5/8in.	1 3/8in.	1 1/4in.	-	½in.	8-32 x 1in. (2)
160mm	Pull	6 15/16in.	5/8in.	1 ½in.	15/16in.	-	½in.	8-32 x 1in. (2)
■ 128mm	Pull	5 29/32in.	5/8in.	1 11/32in.	7/8in.	-	3/8in.	8-32 x 1in. (2)
96mm	Pull	4 ½in.	5/8in.	1 5/8in.	1 1/4in.	-	3/8in.	8-32 x 1in. (2)
-	Knob	1 7/16in.	1in.	1 3/16in.	59/64in.	-	5/16in.	8-32 x 1in. (1)

*Product not shown, please visit BerensonHardware.com to view images and details.

Dierdra Available Finishes, Sizes & Part Numbers

Handle Underside: Curved

NEW
Lengths &
Finishes

BRUSHED NICKEL		MATTE BLACK		MODERN BRUSHED GOLD		POLISHED NICKEL	
■ 12in. CC	9854-1BPN-P	12in. CC	4172-1055-P	12in. CC	4166-1MDB-P	■ 12in. CC	9852-1014-P
224mm CC	9564-1BPN-P	224mm CC	4169-1055-P	224mm CC	4165-1MDB-P	224mm CC	9568-1014-P
160mm CC	9562-1BPN-P	160mm CC	4168-1055-P	160mm CC	4164-1MDB-P	160mm CC	9567-1014-P
■ 128mm CC	9853-1BPN-P	128mm CC	4167-1055-P	128mm CC	4163-1MDB-P	■ 128mm CC	9835-1014-P
96mm CC	4056-1BPN-P	96mm CC	4157-1055-P	96mm CC	4160-1MDB-P	96mm CC	4107-1014-P
Knob	4061-1BPN-P	Knob	4158-1055-P	Knob	4162-1MDB-P	Knob	4110-1014-P

TOASTED BRONZE		VINTAGE NICKEL		WEATHERED NICKEL	
12in. CC	4218-10TB-P	■ 12in. CC	9804-1VTN-P	■ 12in. CC	9802-10WN-P
224mm CC	4217-10TB-P	224mm CC	9808-1VTN-P	224mm CC	9811-10WN-P
160mm CC	4216-10TB-P	160mm CC	9807-1VTN-P	160mm CC	9810-10WN-P
128mm CC	4215-10TB-P	■ 128mm CC	9803-1VTN-P	■ 128mm CC	9801-10WN-P
96mm CC	4214-10TB-P	96mm CC	9806-1VTN-P	96mm CC	4058-10WN-P
Knob	4213-10TB-P	Knob	9809-1VTN-P	Knob	4065-10WN-P



Featuring the Domestic Bliss Collection in Modern Brushed Gold Design and photos by Jennifer Hutton at Artisan Kitchens and Baths, @JenniferHutton_Pro

DOMESTIC BLISS

CLASSIC COMFORT - *Transitional Style*

Collection Featured in Modern Brushed Gold



Appliance Pull
Also Available

18in. CC

160mm CC

128mm CC

96mm CC

Knob

Domestic Bliss Product Data

Collection Material: Zinc

CC	Product Type	Length	Width	Height/Projection	Hand Clearance	Diameter	Base	Tap/Screws (Qty)
*18in.	Appliance Pull	19 5/2in.	1 3/16in.	2 5/2in.	1 1/2in.	-	1 5/2in.	10-24 x 1in. (2)
*320mm	Pull	13 1/2in.	1 in.	1 1/2in.	1 1/16in.	-	1 5/16in.	8-32 x 1in. (2)
224mm	Pull	9 3/4in.	1 3/16in.	1 1/2in.	1 1/16in.	-	1 5/16in.	8-32 x 1in. (2)
160mm	Pull	7 1/8in.	3/4in.	1 7/8in.	1 1/16in.	-	7/8in.	8-32 x 1in. (2)
128mm	Pull	5 3/4in.	5/8in.	1 3/8in.	1 1/16in.	-	3/4in.	8-32 x 1in. (2)
96mm	Pull	4 1/2in.	5/8in.	1 3/8in.	1 1/16in.	-	3/4in.	8-32 x 1in. (2)
-	Knob	-	-	1 1/8in.	-	1 3/16in.	1 1/8in.	8-32 x 1in. (1)

*Product not shown, please visit BerensonHardware.com to view images and details.

Domestic Bliss Available Finishes, Sizes & Part Numbers

Handle Underside: Curved

NEW
18in. CC Length
coming spring 2024



BRUSHED NICKEL

18in. CC	2419-1BPN-P
320mm CC	2356-1BPN-P
224mm CC	2352-1BPN-P
160mm CC	2348-1BPN-P
128mm CC	2343-1BPN-P
96mm CC	2339-1BPN-P
Knob	2360-1BPN-P



MATTE BLACK

18in. CC	2420-1055-P
320mm CC	2410-1055-P
224mm CC	2409-1055-P
160mm CC	2402-1055-P
128mm CC	2401-1055-P
96mm CC	2400-1055-P
Knob	2399-1055-P



MODERN BRUSHED GOLD

18in. CC	2421-1MDB-P
320mm CC	2359-1MDB-P
224mm CC	2355-1MDB-P
160mm CC	2351-1MDB-P
128mm CC	2347-1MDB-P
96mm CC	2342-1MDB-P
Knob	2363-1MDB-P



POLISHED NICKEL

18in. CC	Not Available
320mm CC	2358-1014-P
224mm CC	2354-1014-P
160mm CC	2350-1014-P
128mm CC	2346-1014-P
96mm CC	2341-1014-P
Knob	2362-1014-P



SLATE

18in. CC	Not Available
320mm CC	2408-1SLT-P
224mm CC	2407-1SLT-P
160mm CC	2406-1SLT-P
128mm CC	2405-1SLT-P
96mm CC	2404-1SLT-P
Knob	2403-1SLT-P



VERONA BRONZE

18in. CC	Not Available
320mm CC	2357-10VB-P
224mm CC	2353-10VB-P
160mm CC	2349-10VB-P
128mm CC	2344-10VB-P
96mm CC	2340-10VB-P
Knob	2361-10VB-P

EURO MODERNO

CLASSIC COMFORT - *Transitional Style*
Collection Featured in Brushed Nickel



Euro Moderno Available Finishes, Sizes & Part Numbers

Handle Underside: Curved

BRUSHED ANTIQUE BRASS		BRUSHED ANTIQUE COPPER		BRUSHED BLACK NICKEL		BRUSHED NICKEL	
96mm CC	9721-1BAB-P	96mm CC	9719-1BAC-P	96mm CC	9720-1BBN-P	96mm CC	9718-1BPN-P
64mm CC	9713-1BAB-P	64mm CC	9711-1BAC-P	64mm CC	9712-1BBN-P	64mm CC	9710-1BPN-P
Knob	9724-1BAB-P	Knob	9722-1BAC-P	Knob	9723-1BBN-P	Knob	9913-1BPN-P

Euro Moderno Product Data

CC	Product Type	Length	Width	Height/Projection	Hand Clearance	Diameter	Base	Tap/Screws (Qty)
96mm	Pull	5 1/4in.	5/8in.	1 5/16in.	2 3/32in.	-	7/16in.	8-32 x 1in. (2)
64mm	Cup Pull	3 1/4in.	1 1/8in.	1 5/16in.	2 7/32in.	-	-	8-32 x 1in. (2)
-	Knob	-	-	1 1/16in.	3 5/16in.	1 1/8in.	5/16in.	8-32 x 1in. (1)

Collection Material: Zinc

FORTÉ

CLASSIC COMFORT - *Transitional Style*
Collection Featured in Weathered Nickel



Appliance Pull
Also Available
18in. CC

Forté Available Finishes, Sizes & Part Numbers

Handle Underside: Curved

+2 Additional 8-32 x 1 3/4in. break-off screws provided for pull. 1 Additional 8-32 x 1 3/4in. break-off screw provided for knob.

BRUSHED NICKEL		OIL RUBBED BRONZE		VERONA BRONZE		WEATHERED NICKEL	
18in. CC	8297-1BPN-P	18in. CC	8299-1ORB-P	18in. CC	8298-1VB-P	18in. CC	8300-1WN-P
6in. CC	8267-1BPN-P	6in. CC	8269-1ORB-P	6in. CC	8268-1VB-P	6in. CC	8270-1WN-P
4in. CC	8273-1BPN-P	4in. CC	Not Available	4in. CC	+8274-1VB-P	4in. CC	8276-1WN-P
① Knob	8279-1BPN-P	① Knob	8281-1ORB-P	① Knob	8280-1VB-P	① Knob	8282-1WN-P
② Knob	8285-1BPN-P	② Knob	8287-1ORB-P	② Knob	+8286-1VB-P	② Knob	8288-1WN-P

Forté Product Data

CC	Product Type	Length	Width	Height/Projection	Hand Clearance	Diameter	Base	Tap/Screws (Qty)
*18in.	Appliance Pull	19in.	1 1/8in.	2 1/2in.	1 3/8in.	-	1in.	10-24 x 1in. (2)
**6in.	Pull	6 5/8in.	1 1/8in.	1 7/8in.	1 7/32in.	-	5/16in.	8-32 x 1in. (2)
4in.	Pull	4 3/8in.	1/2in.	1 1/4in.	5 1/4in.	-	3/8in.	8-32 x 1in. (2)
-	① Knob	-	-	1 3/4in.	5 5/8in.	1 1/16in.	3/4in.	8-32 x 1in. (1)
-	② Knob	-	-	1 5/8in.	-	1 1/4in.	1 1/16in.	8-32 x 1in. (1)

*Product not shown, please visit BerensonHardware.com to view images and details.

**The 6in. CC pull features a wider width that adds dimension to kitchen and bath designs.

MEADOW

CLASSIC COMFORT - Transitional Style

Collection Featured in Verona Bronze



Appliance Pull
Also Available

448mm CC

Meadow Product Data

Collection Material: Aluminum

CC	Product Type	Length	Width	Height/Projection	Hand Clearance	Diameter	Base	Tap/Screws (Qty)
*448mm	Appliance Pull	19 1/4in.	2 5/32in.	1 1/4in.	3 1/32in.	-	1 7/32in.	10-24 x 1in. (2)
*320mm	Pull	14 3/16in.	1 1/16in.	1 3/8in.	5 9/64in.	-	1/2in.	8-32 x 1in. (2)
256mm	Pull	11 1 1/16in.	1 1/16in.	1 3/8in.	5 9/64in.	-	1/2in.	8-32 x 1in. (2)
160mm	Pull	7 7/8in.	1 1/16in.	1 3/8in.	5 9/64in.	-	1/2in.	8-32 x 1in. (2)
128mm	Pull	6 5/8in.	1 1/16in.	1 3/8in.	5 9/64in.	-	1/2in.	8-32 x 1in. (2)
96mm	Pull	5 7/16in.	1 1/16in.	1 3/8in.	5 9/64in.	-	1/2in.	8-32 x 1in. (2)
-	Knob	1 3/4in.	1 1/16in.	1 1/4in.	2 7/32in.	-	1/2in.	8-32 x 1in. (1)

*Product not shown, please visit BerensonHardware.com to view images and details.

Meadow Available Finishes, Sizes & Part Numbers

Handle Underside: Curved



BRUSHED NICKEL

448mm CC	2302-4BPN-P
320mm CC	2308-4BPN-P
256mm CC	2306-4BPN-P
160mm CC	2304-4BPN-P
128mm CC	2099-4BPN-P
96mm CC	2097-4BPN-P
Knob	2310-1BPN-P



GRAPHITE

448mm CC	2285-4GPH-P
320mm CC	2284-4GPH-P
256mm CC	2283-4GPH-P
160mm CC	2282-4GPH-P
128mm CC	2281-4GPH-P
96mm CC	2280-4GPH-P
Knob	2286-4GPH-P



MATTE BLACK

448mm CC	2292-4055-P
320mm CC	2291-4055-P
256mm CC	2290-4055-P
160mm CC	2289-4055-P
128mm CC	2288-4055-P
96mm CC	2287-4055-P
Knob	2293-4055-P



POLISHED CHROME

448mm CC	2299-4026-P
320mm CC	2298-4026-P
256mm CC	2297-4026-P
160mm CC	2296-4026-P
128mm CC	2295-4026-P
96mm CC	2294-4026-P
Knob	2300-4026-P



SATIN GOLD

448mm CC	2278-40SG-P
320mm CC	2277-40SG-P
256mm CC	2276-40SG-P
160mm CC	2275-40SG-P
128mm CC	2274-40SG-P
96mm CC	2273-40SG-P
Knob	2279-40SG-P



VERONA BRONZE

448mm CC	2301-40VB-P
320mm CC	2309-40VB-P
256mm CC	2307-40VB-P
160mm CC	2305-40VB-P
128mm CC	2303-40VB-P
96mm CC	2098-40VB-P
Knob	2311-10VB-P



OASIS

CLASSIC COMFORT - *Transitional Style*

Collection Featured in Brushed Tin



Oasis Available Finishes, Sizes & Part Numbers

Handle Underside: Flat

+2 Additional 8-32 x 1 3/4in. break-off screws provided for pull. 1 Additional 8-32 x 1 3/4in. break-off screw provided for knob.



BRUSHED NICKEL

160mm CC	9252-1BPN-P
128mm CC	9249-1BPN-P
96mm CC	9246-1BPN-P
Knob	9255-1BPN-P



BRUSHED TIN

160mm CC	+9253-10BT-P
128mm CC	9250-10BT-P
96mm CC	9247-10BT-P
Knob	+9256-10BT-P



OIL RUBBED BRONZE

160mm CC	9251-1ORB-P
128mm CC	9248-1ORB-P
96mm CC	9245-1ORB-P
Knob	9254-1ORB-P

Oasis Product Data

Collection Material: Zinc

CC	Product Type	Length	Width	Height/Projection	Hand Clearance	Diameter	Base	Tap/Screws (Qty)
160mm	Pull	7 5/8in.	1 3/8in.	1 1/8in.	6 3/8in.	-	1 1/8in.	8-32 x 1in. (2)
128mm	Pull	6 1/8in.	1 3/8in.	1 1/8in.	6 3/8in.	-	1 1/8in.	8-32 x 1in. (2)
96mm	Pull	4 7/8in.	1 3/8in.	1 1/8in.	6 3/8in.	-	1 1/8in.	8-32 x 1in. (2)
-	Knob	-	-	1 1/8in.	-	1 1/8in.	5/8in.	8-32 x 1in. (1)

A modern take on a classic design, these pulls add a *familiar visual element* to cabinets.





Featuring the Rivet Rebel Collection
in Matte Black and Brushed Nickel



RIVET REBEL

CLASSIC COMFORT - *Transitional Style*
Collection Featured in Brushed Nickel and Matte Black



Appliance Pulls
Also Available
18in. CC & 12in. CC

Rivet Rebel Product Data

Collection Material: Aluminum

CC	Product Type	Length	Width	Height/Projection	Hand Clearance	Diameter	Base	Tap/Screws (Qty)
*18in.	Appliance Pull	21 1/2in.	7/8in.	2 5/8in.	2 3/8in.	-	9/16in.	10-24 x 1in. (2)
*12in.	Appliance Pull	14 3/8in.	23/32in.	1 7/16in.	1 3/16in.	-	1/2in.	10-24 x 1in. (2)
224mm	Pull	11 3/16in.	23/32in.	1 7/16in.	1 3/16in.	-	1/2in.	8-32 x 1in. (2)
160mm	Pull	8 21/32in.	23/32in.	1 7/16in.	1 3/16in.	-	1/2in.	8-32 x 1in. (2)
128mm	Pull	7 13/32in.	23/32in.	1 7/16in.	1 3/16in.	-	1/2in.	8-32 x 1in. (2)
96mm	Pull	6 5/32in.	23/32in.	1 7/16in.	1 3/16in.	-	1/2in.	8-32 x 1in. (2)
-	Knob	2in.	23/32in.	1 7/16in.	1 3/16in.	-	1/2in.	8-32 x 1in. (1)

*Product not shown, please visit BerensonHardware.com to view images and details.

screw offering subject to change

Rivet Rebel Available Finishes, Sizes & Part Numbers

Handle Underside: Flat

NEW
18in. CC Length
coming spring 2024



BRUSHED NICKEL

18in. CC	5133-4BPN-P
12in. CC	5083-4BPN-P
224mm CC	5082-4BPN-P
160mm CC	5081-4BPN-P
128mm CC	5080-4BPN-P
96mm CC	5079-4BPN-P
Knob	5078-4BPN-P



BRUSHED NICKEL AND MATTE BLACK

18in. CC	Not Available
12in. CC	5125-4BPN55-P
224mm CC	5124-4BPN55-P
160mm CC	5123-4BPN55-P
128mm CC	5122-4BPN55-P
96mm CC	5121-4BPN55-P
Knob	5120-4BPN55-P



MATTE BLACK

18in. CC	5134-4055-P
12in. CC	5095-4055-P
224mm CC	5094-4055-P
160mm CC	5093-4055-P
128mm CC	5092-4055-P
96mm CC	5091-4055-P
Knob	5090-4055-P



MATTE BLACK AND BRUSHED NICKEL

18in. CC	Not Available
12in. CC	5119-455BPN-P
224mm CC	5118-455BPN-P
160mm CC	5117-455BPN-P
128mm CC	5116-455BPN-P
96mm CC	5115-455BPN-P
Knob	5114-455BPN-P



MATTE BLACK AND MODERN BRUSHED GOLD

18in. CC	5132-455MDB-P
12in. CC	5113-455MDB-P
224mm CC	5112-455MDB-P
160mm CC	5111-455MDB-P
128mm CC	5110-455MDB-P
96mm CC	5109-455MDB-P
Knob	5108-455MDB-P



MODERN BRUSHED GOLD

18in. CC	5135-4MDB-P
12in. CC	5107-4MDB-P
224mm CC	5106-4MDB-P
160mm CC	5105-4MDB-P
128mm CC	5104-4MDB-P
96mm CC	5103-4MDB-P
Knob	5102-4MDB-P



POLISHED CHROME

18in. CC	Not Available
12in. CC	5089-4026-P
224mm CC	5088-4026-P
160mm CC	5087-4026-P
128mm CC	5086-4026-P
96mm CC	5085-4026-P
Knob	5084-4026-P



SLATE

18in. CC	Not Available
12in. CC	5101-4SLT-P
224mm CC	5100-4SLT-P
160mm CC	5099-4SLT-P
128mm CC	5098-4SLT-P
96mm CC	5097-4SLT-P
Knob	5096-4SLT-P



SLATE AND MATTE BLACK

18in. CC	Not Available
12in. CC	5131-4SLT55-P
224mm CC	5130-4SLT55-P
160mm CC	5129-4SLT55-P
128mm CC	5128-4SLT55-P
96mm CC	5127-4SLT55-P
Knob	5126-4SLT55-P

SUBTLE SURGE

CLASSIC COMFORT - *Transitional Style*

Collection Featured in Matte Black



Appliance Pulls
Also Available

18in. CC & 12in. CC

Knob
has tooth at bottom to
help secure in position

Subtle Surge Product Data

Collection Material: Zinc

CC	Product Type	Length	Width	Height/ Projection	Hand Clearance	Diameter	Base	Tap/Screws (Qty)
*18in.	Appliance Pull	18 7/16in.	2 5/32in.	2 3/32in.	1 3/8in.	-	1 1/2in.	10-24 x 1in. (2)
*12in.	Appliance Pull	12 5/8in.	1 1/8in.	1 5/8in.	1 1/8in.	-	5/8in.	10-24 x 1in. (2)
224mm	Pull	9 3/8in.	1/2in.	1 3/8in.	6 3/4in.	-	7/8in.	8-32 x 1in. (2)
160mm	Pull	6 1 5/16in.	1 5/32in.	1 3/8in.	6 3/4in.	-	1 3/32in.	8-32 x 1in. (2)
128mm	Pull	5 9/16in.	7/16in.	1 3/8in.	6 3/4in.	-	3/8in.	8-32 x 1in. (2)
96mm	Pull	4 3/8in.	7/16in.	1 1/8in.	1 5/16in.	-	3/8in.	8-32 x 1in. (2)
-	Knob	1 9/16in.	3/4in.	1 1/4in.	2 9/32in.	-	1/2in.	8-32 x 1in. (1)

*Product not shown, please visit BerensonHardware.com to view images and details.

Subtle Surge Available Finishes, Sizes & Part Numbers

Handle Underside: Flat



BRUSHED NICKEL

18in. CC	1115-1BPN-P
12in. CC	1266-1BPN-P
224mm CC	1260-1BPN-P
160mm CC	1254-1BPN-P
128mm CC	1248-1BPN-P
96mm CC	1242-1BPN-P
Knob	1236-1BPN-P



MATTE BLACK

18in. CC	1119-1055-P
12in. CC	1269-1055-P
224mm CC	1263-1055-P
160mm CC	1257-1055-P
128mm CC	1251-1055-P
96mm CC	1245-1055-P
Knob	1239-1055-P



MODERN BRUSHED GOLD

18in. CC	1114-1MDB-P
12in. CC	1270-1MDB-P
224mm CC	1264-1MDB-P
160mm CC	1258-1MDB-P
128mm CC	1252-1MDB-P
96mm CC	1246-1MDB-P
Knob	1240-1MDB-P



POLISHED NICKEL

18in. CC	1116-1014-P
12in. CC	1268-1014-P
224mm CC	1262-1014-P
160mm CC	1256-1014-P
128mm CC	1250-1014-P
96mm CC	1244-1014-P
Knob	1238-1014-P



VERONA BRONZE

18in. CC	1117-10VB-P
12in. CC	1267-10VB-P
224mm CC	1261-10VB-P
160mm CC	1255-10VB-P
128mm CC	1249-10VB-P
96mm CC	1243-10VB-P
Knob	1237-10VB-P



VINTAGE NICKEL

18in. CC	1118-1VTN-P
12in. CC	1271-1VTN-P
224mm CC	1265-1VTN-P
160mm CC	1259-1VTN-P
128mm CC	1253-1VTN-P
96mm CC	1247-1VTN-P
Knob	1241-1VTN-P

TEMPO

CLASSIC COMFORT - *Transitional Style*

Collection Featured in Brushed Nickel

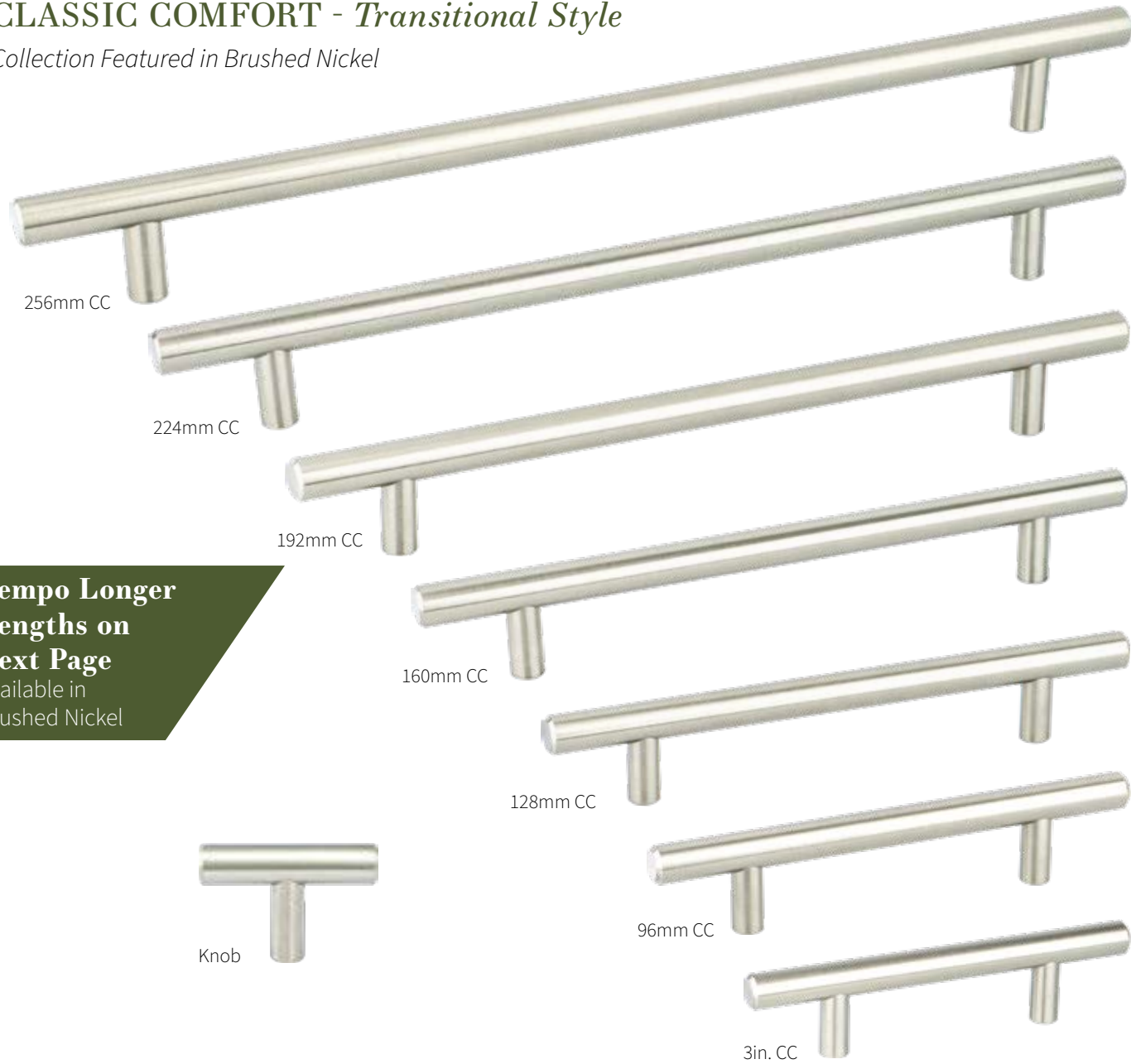

Tempo Longer Lengths on Next Page
Available in Brushed Nickel

Tempo Product Data

Collection Material: Steel

CC	Product Type	Length	Width	Height/Projection	Hand Clearance	Diameter	Base	Tap/Screws (Qty)
*320mm	Pull	15in.	½in.	1 ¼in.	2 ⁵ / ₃₂ in.	-	¾in.	8-32 x 1in. (2)
256mm	Pull	12 7/16in.	½in.	1 ¼in.	2 ⁵ / ₃₂ in.	-	¾in.	8-32 x 1in. (2)
224mm	Pull	11 ¾in.	½in.	1 ¼in.	2 ⁵ / ₃₂ in.	-	¾in.	8-32 x 1in. (2)
192mm	Pull	9 1 ⁹ / ₁₆ in.	½in.	1 ¼in.	2 ⁵ / ₃₂ in.	-	¾in.	8-32 x 1in. (2)
160mm	Pull	8 1 ¹ / ₁₆ in.	½in.	1 ¼in.	2 ⁵ / ₃₂ in.	-	¾in.	8-32 x 1in. (2)
128mm	Pull	7 ¾in.	½in.	1 ¼in.	2 ⁵ / ₃₂ in.	-	¾in.	8-32 x 1in. (2)
96mm	Pull	6 ½in.	½in.	1 ¼in.	2 ⁵ / ₃₂ in.	-	¾in.	8-32 x 1in. (2)
3in.	Pull	5 9/16in.	½in.	1 ¼in.	2 ⁵ / ₃₂ in.	-	¾in.	8-32 x 1in. (2)
-	Knob	2in.	½in.	1 ¼in.	2 ⁵ / ₃₂ in.	-	¾in.	8-32 x 1in. (1)

*Product not shown, please visit BerensonHardware.com to view images and details.

47 | CC = center to center | images of parts are not shown at 100% scale

Tempo Available Finishes, Sizes & Part Numbers

Handle Underside: Curved



BLACK

320mm CC	0838-2055-P
256mm CC	0836-2055-P
224mm CC	0835-2055-P
192mm CC	0834-2055-P
160mm CC	0833-2055-P
128mm CC	0832-2055-P
96mm CC	0831-2055-P
3in. CC	0830-2055-P
Knob	0839-2055-P



BRUSHED NICKEL

320mm CC	0810-2BPN-P
256mm CC	0808-2BPN-P
224mm CC	1127-2BPN-P
192mm CC	0806-2BPN-P
160mm CC	1126-2BPN-P
128mm CC	0804-2BPN-P
96mm CC	0802-2BPN-P
3in. CC	0800-2BPN-P
Knob	2020-2BPN-P



MODERN BRUSHED GOLD

320mm CC	0828-2MDB-P
256mm CC	0826-2MDB-P
224mm CC	0825-2MDB-P
192mm CC	0824-2MDB-P
160mm CC	0823-2MDB-P
128mm CC	0822-2MDB-P
96mm CC	0821-2MDB-P
3in. CC	0820-2MDB-P
Knob	0829-2MDB-P



POLISHED CHROME

320mm CC	2006-2026-P
256mm CC	2017-2026-P
224mm CC	2016-2026-P
192mm CC	2015-2026-P
160mm CC	2028-2026-P
128mm CC	2014-2026-P
96mm CC	2013-2026-P
3in. CC	2012-2026-P
Knob	2019-2026-P



VERONA BRONZE

320mm CC	0811-20VB-P
256mm CC	0809-20VB-P
224mm CC	0813-20VB-P
192mm CC	0807-20VB-P
160mm CC	0812-20VB-P
128mm CC	0805-20VB-P
96mm CC	0803-20VB-P
3in. CC	0801-20VB-P
Knob	2018-20VB-P

Tempo Longer Lengths • Only Available in Brushed Nickel

Handle Underside: Curved



Tempo Product Data

Collection Material: Steel

CC	Product Type	Length	Width	Height/ Projection	Hand Clearance	Diameter	Base	Tap/Screws (Qty)
768mm	Pull	32 5/8in.	1/2in.	1 1/4in.	2 5/32in.	-	3/8in.	8-32 x 1in. (2)
640mm	Pull	27 1/8in.	1/2in.	1 1/4in.	2 5/32in.	-	3/8in.	8-32 x 1in. (2)
544mm	Pull	23 3/8in.	1/2in.	1 1/4in.	2 5/32in.	-	3/8in.	8-32 x 1in. (2)
448mm	Pull	20in.	1/2in.	1 1/4in.	2 5/32in.	-	3/8in.	8-32 x 1in. (2)
384mm	Pull	17 1/2in.	1/2in.	1 1/4in.	2 5/32in.	-	3/8in.	8-32 x 1in. (2)
288mm	Pull	13 1/8in.	1/2in.	1 1/4in.	2 5/32in.	-	3/8in.	8-32 x 1in. (2)

Simple, designs
that *complement*
transitional style.



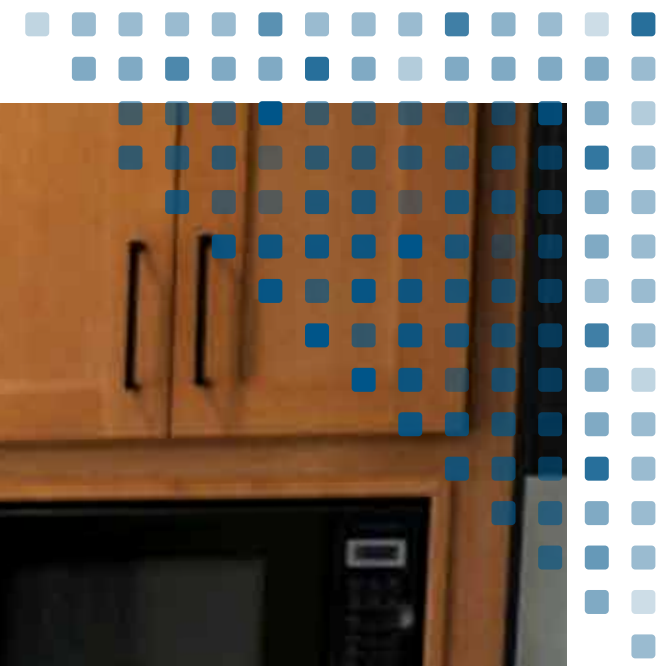

Featuring the Metro Collection in Matte Black
Design and photos by Jennifer Hutton at
Grau Design Studio, @JenniferHutton_Pro

UPTOWN *APPEAL*

Contemporary Style

Favor clean lines & subtle flair in minimalist hardware designs for a sleek approach to home design.



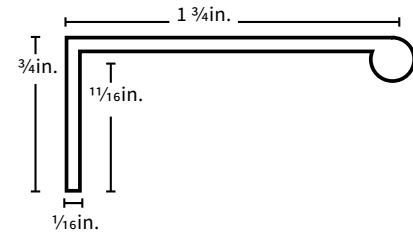

Aluminum Edge Pull Also Available (1051-4ALU-B)*



*Pull measures 96 7/16 in. long and is made for you to cut down to your required size.

Bravo Available Finishes, Sizes & Part Numbers

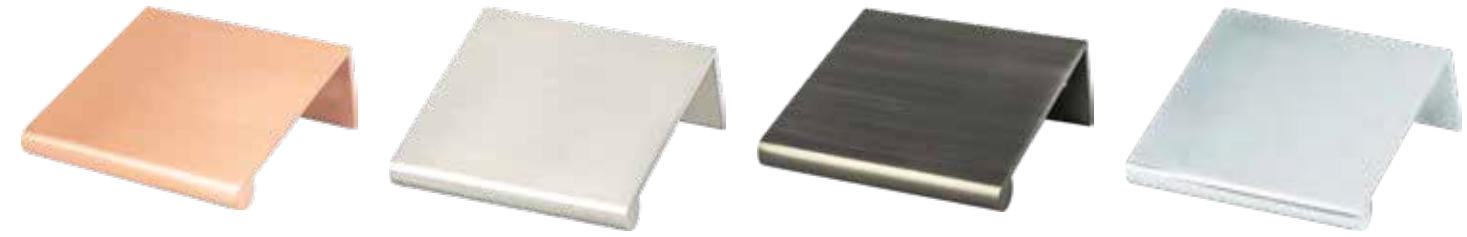

BRUSHED COPPER		BRUSHED NICKEL		GRAPHITE		POLISHED CHROME	
169mm CC	1049-40BC-P	169mm CC	1065-4BPN-P	169mm CC	1076-4GPH-P	169mm CC	1066-4026-P
112mm CC	1048-40BC-P	112mm CC	1061-4BPN-P	112mm CC	1075-4GPH-P	112mm CC	1062-4026-P
56mm CC	1047-40BC-P	56mm CC	1057-4BPN-P	56mm CC	1074-4GPH-P	56mm CC	1058-4026-P
32mm CC	1046-40BC-P	32mm CC	1052-4BPN-P	32mm CC	1073-4GPH-P	32mm CC	1053-4026-P



SATIN BLACK		SATIN GOLD		VERONA BRONZE	
169mm CC	1068-4055-P	169mm CC	1072-40SG-P	169mm CC	1067-40VB-P
112mm CC	1064-4055-P	112mm CC	1071-40SG-P	112mm CC	1063-40VB-P
56mm CC	1060-4055-P	56mm CC	1070-40SG-P	56mm CC	1059-40VB-P
32mm CC	1056-4055-P	32mm CC	1069-40SG-P	32mm CC	1055-40VB-P

Bravo Product Data

Collection Material: Aluminum

CC	Product Type	Length	Width	Height/Projection	Hand Clearance	Diameter	Base	Screws (Qty)
169mm	Edge Pull	9 1/4 in.	3/4 in.	1 3/4 in.	-	-	1 1/2 in.	3/8 in. Wood (2)
112mm	Edge Pull	6 in.	3/4 in.	1 3/4 in.	-	-	1 1/2 in.	3/8 in. Wood (2)
56mm	Edge Pull	3 in.	3/4 in.	1 3/4 in.	-	-	1 1/2 in.	3/8 in. Wood (2)
32mm	Edge Pull	1 3/4 in.	3/4 in.	1 3/4 in.	-	-	1 1/2 in.	3/8 in. Wood (2)

UPTOWN APPEAL - Contemporary Style

Collection Featured in Verona Bronze



256mm CC



160mm CC



128mm CC



96mm CC



① Knob



② Knob

Appliance Pulls Also Available

18in. CC & 320mm CC

Collection Material: Aluminum
Knob ② Material: Zinc

Elevate Product Data

CC	Product Type	Length	Width	Height/Projection	Hand Clearance	Diameter	Base	Tap/Screws (Qty)
*18in.	Appliance Pull	19 5/16in.	1 3/16in.	2in.	1 3/16in.	-	1 3/16in.	10-24 x 1in. (2)
*320mm	Appliance Pull	13 1/8in.	3/4in.	1 1/8in.	5 1/4in.	-	9/16in.	10-24 x 1in. (2)
256mm	Pull	10 5/8in.	3/4in.	1 1/8in.	5 1/4in.	-	9/16in.	8-32 x 1in. (2)
160mm	Pull	6 1 3/16in.	3/4in.	1 1/8in.	5 1/4in.	-	9/16in.	8-32 x 1in. (2)
128mm	Pull	5 5/8in.	3/4in.	1 1/8in.	5 1/4in.	-	9/16in.	8-32 x 1in. (2)
96mm	Pull	4 5/8in.	3/4in.	1 1/8in.	5 1/4in.	-	9/16in.	8-32 x 1in. (2)
-	① Knob	1 5/8in.	1 1/8in.	1 1/8in.	3 5/4in.	-	1 5/16in.	8-32 x 1in. (1)
-	② Knob	1 3/8in.	1 3/16in.	7/8in.	1 9/32in.	-	1 9/32in.	8-32 x 1in. (1)

*Product not shown, please visit BerensonHardware.com to view images and details.

Elevate Available Finishes, Sizes & Part Numbers

Handle Underside: Curved



BRUSHED NICKEL

18in. CC	2101-4BPN-P
320mm CC	2093-4BPN-P
256mm CC	2091-4BPN-P
160mm CC	2089-4BPN-P
128mm CC	2087-4BPN-P
96mm CC	2085-4BPN-P
① Knob	2095-4BPN-P
② Knob	2172-1BPN-P



GRAPHITE

18in. CC	2114-4GPH-P
320mm CC	2113-4GPH-P
256mm CC	2112-4GPH-P
160mm CC	2111-4GPH-P
128mm CC	2110-4GPH-P
96mm CC	2109-4GPH-P
① Knob	2115-4GPH-P
② Knob	2174-1GPH-P



MATTE BLACK

18in. CC	2121-4055-P
320mm CC	2120-4055-P
256mm CC	2119-4055-P
160mm CC	2118-4055-P
128mm CC	2117-4055-P
96mm CC	2116-4055-P
① Knob	2122-4055-P
② Knob	2175-1055-P



POLISHED CHROME

18in. CC	2128-4026-P
320mm CC	2127-4026-P
256mm CC	2126-4026-P
160mm CC	2125-4026-P
128mm CC	2124-4026-P
96mm CC	2123-4026-P
① Knob	2129-4026-P
② Knob	2176-1026-P



SATIN GOLD

18in. CC	2107-40SG-P
320mm CC	2106-40SG-P
256mm CC	2105-40SG-P
160mm CC	2104-40SG-P
128mm CC	2103-40SG-P
96mm CC	2102-40SG-P
① Knob	2108-40SG-P
② Knob	2173-10SG-P



VERONA BRONZE

18in. CC	2100-40VB-P
320mm CC	2094-40VB-P
256mm CC	2092-40VB-P
160mm CC	2090-40VB-P
128mm CC	2088-40VB-P
96mm CC	2086-40VB-P
① Knob	2096-40VB-P
② Knob	2177-10VB-P

EPOCH EDGE

UPTOWN APPEAL - Contemporary Style

Collection Featured in Modern Brushed Gold

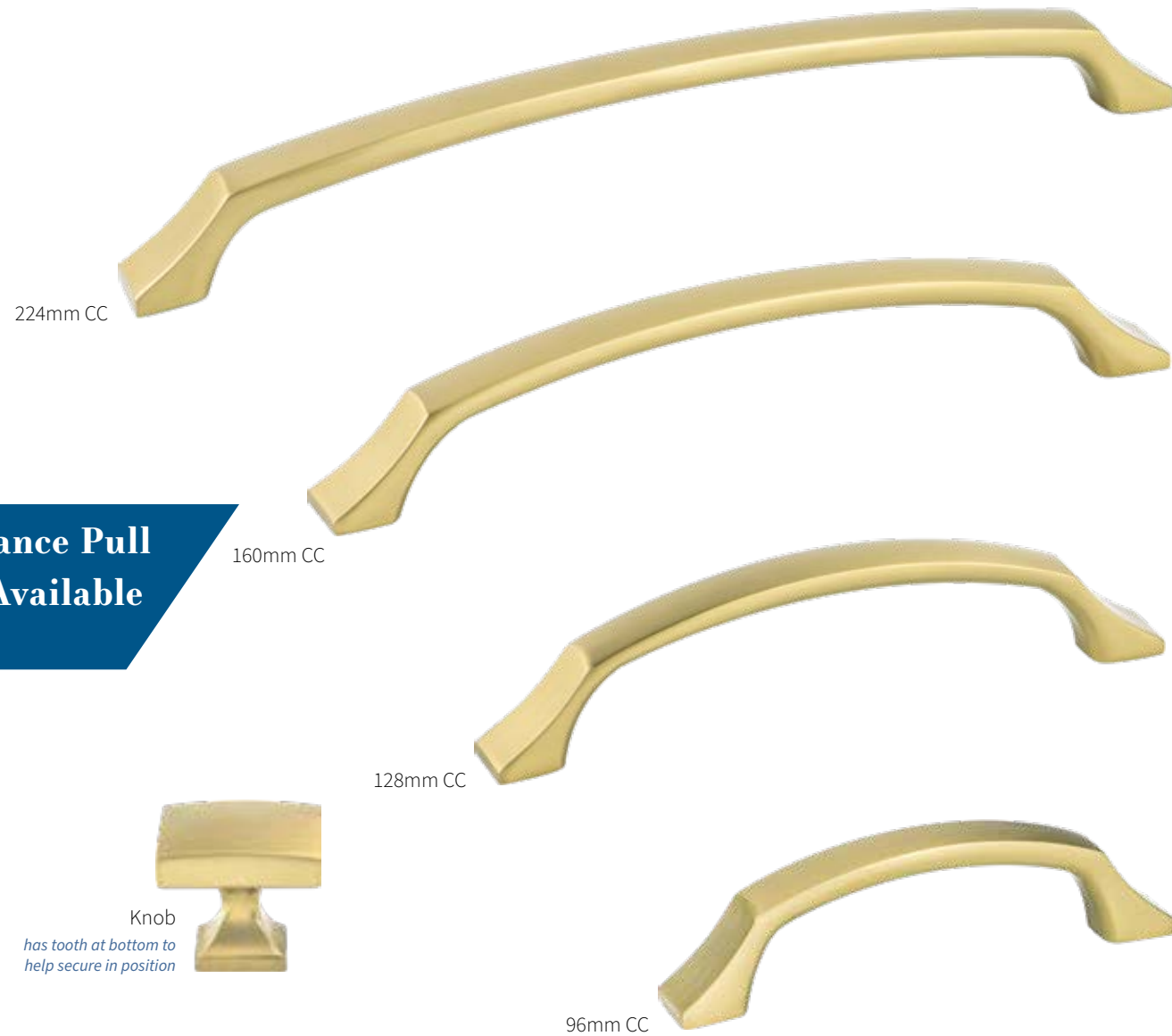

Appliance Pull
Also Available

12in. CC

Epoch Edge Product Data

Collection Material: Zinc

CC	Product Type	Length	Width	Height/Projection	Hand Clearance	Diameter	Base	Tap/Screws (Qty)
*12in.	Appliance Pull	12 7/8in.	7/8in.	1 1/8in.	1 3/32in.	-	1in.	10-24 x 1in. (2)
224mm	Pull	9 1/2in.	1 1/8in.	1 3/8in.	1 3/16in.	-	1 1/8in.	8-32 x 1in. (2)
160mm	Pull	7 1/8in.	5/8in.	1 5/16in.	1 1/32in.	-	5/8in.	8-32 x 1in. (2)
128mm	Pull	5 1/8in.	5/8in.	1 5/16in.	1 1/32in.	-	5/8in.	8-32 x 1in. (2)
96mm	Pull	4 7/8in.	5/8in.	1 3/8in.	2 3/32in.	-	5/8in.	8-32 x 1in. (2)
-	Knob	1 3/8in.	1 1/8in.	1 1/8in.	7/8in.	-	5/8in.	8-32 x 1in. (1)

*Product not shown, please visit BerensonHardware.com to view images and details.

Epoch Edge Available Finishes, Sizes & Part Numbers

Handle Underside: Semi-Curved



BRUSHED NICKEL

12in. CC	1230-1BPN-P
224mm CC	1224-1BPN-P
160mm CC	1218-1BPN-P
128mm CC	1212-1BPN-P
96mm CC	1206-1BPN-P
Knob	1200-1BPN-P



MATTE BLACK

12in. CC	1233-1055-P
224mm CC	1227-1055-P
160mm CC	1221-1055-P
128mm CC	1215-1055-P
96mm CC	1209-1055-P
Knob	1203-1055-P



MODERN BRUSHED GOLD

12in. CC	1234-1MDB-P
224mm CC	1228-1MDB-P
160mm CC	1222-1MDB-P
128mm CC	1216-1MDB-P
96mm CC	1210-1MDB-P
Knob	1204-1MDB-P



POLISHED CHROME

12in. CC	1232-1026-P
224mm CC	1226-1026-P
160mm CC	1220-1026-P
128mm CC	1214-1026-P
96mm CC	1208-1026-P
Knob	1202-1026-P



VERONA BRONZE

12in. CC	1231-10VB-P
224mm CC	1225-10VB-P
160mm CC	1219-10VB-P
128mm CC	1213-10VB-P
96mm CC	1207-10VB-P
Knob	1201-10VB-P



VINTAGE NICKEL

12in. CC	1235-1VTN-P
224mm CC	1229-1VTN-P
160mm CC	1223-1VTN-P
128mm CC	1217-1VTN-P
96mm CC	1211-1VTN-P
Knob	1205-1VTN-P



Fluidic Available Finishes, Sizes & Part Numbers

Handle Underside: Flat



BLACK

128mm CC	9440-1055-P
96mm CC	9439-1055-P
Knob	9441-1055-P



BRUSHED NICKEL

128mm CC	9478-1BPN-P
96mm CC	9476-1BPN-P
Knob	9480-1BPN-P



POLISHED CHROME

128mm CC	9477-1026-P
96mm CC	9475-1026-P
Knob	9479-1026-P

Fluidic Product Data

Collection Material: Zinc

CC	Product Type	Length	Width	Height/Projection	Hand Clearance	Diameter	Base	Tap/Screws (Qty)
128mm	Pull	6 1/4in.	1 3/4in.	1 3/4in.	1 5/8in.	-	7/8in.	8-32 x 1in. (2)
96mm	Pull	4 1/4in.	1 3/4in.	1 3/4in.	6/8in.	-	7/8in.	8-32 x 1in. (2)
-	Knob	1 3/4in.	1 1/2in.	1 1/4in.	-	-	1 1/4in.	8-32 x 1in. (1)

Slight peaks flow diagonally across the surface like gentle waves rolling over a body of water.





Featuring the Laura Collection in Vintage Nickel



224mm CC



160mm CC



128mm CC



96mm CC



Knob

has tooth at bottom to help secure in position

**Appliance Pull
Also Available**

12in. CC

Laura Product Data

Collection Material: Zinc

CC	Product Type	Length	Width	Height/Projection	Hand Clearance	Diameter	Base	Tap/Screws (Qty)
■ *12in.	Appliance Pull	13 3/4in.	1 1/2in.	1 1/2in.	1 1/4in.	-	3/16in.	10-24 x 1in. (2)
224mm	Pull	9 3/4in.	1 3/16in.	1 3/16in.	5/16in.	-	3/16in.	8-32 x 1in. (2)
160mm	Pull	7 1/4in.	1 3/16in.	1 1/16in.	2 9/32in.	-	3/16in.	8-32 x 1in. (2)
128mm	Pull	6in.	7/8in.	1in.	7/8in.	-	3/16in.	8-32 x 1in. (2)
96mm	Pull	4 7/8in.	7/8in.	1in.	5 5/16in.	-	3/16in.	8-32 x 1in. (2)
-	Knob	1 7/8in.	1in.	1in.	5/8in.	-	7/16in.	8-32 x 1in. (1)

*Product not shown, please visit BerensonHardware.com to view images and details.

Laura Available Finishes, Sizes & Part Numbers

Handle Underside: Flat

**NEW
Lengths &
Finishes**



BRUSHED NICKEL

■ 12in. CC	4193-1BPN-P
224mm CC	9813-1BPN-P
160mm CC	9812-1BPN-P
128mm CC	4077-1BPN-P
96mm CC	4072-1BPN-P
Knob	4088-1BPN-P



MATTE BLACK

12in. CC	4212-1055-P
224mm CC	4211-1055-P
160mm CC	4210-1055-P
128mm CC	4209-1055-P
96mm CC	4208-1055-P
Knob	4207-1055-P



MODERN BRUSHED GOLD

■ 12in. CC	4194-1MDB-P
224mm CC	9817-1MDB-P
160mm CC	9816-1MDB-P
128mm CC	9815-1MDB-P
96mm CC	9814-1MDB-P
Knob	9818-1MDB-P



POLISHED CHROME

■ 12in. CC	4195-1026-P
224mm CC	9820-1026-P
160mm CC	9819-1026-P
128mm CC	4087-1026-P
96mm CC	4084-1026-P
Knob	4090-1026-P



VINTAGE NICKEL

■ 12in. CC	4196-1VTN-P
224mm CC	9824-1VTN-P
160mm CC	9823-1VTN-P
128mm CC	9822-1VTN-P
96mm CC	9821-1VTN-P
Knob	9827-1VTN-P



Featuring the Metro Collection in Slate

UPTOWN APPEAL - Contemporary Style

Collection Featured in Matte Black



Appliance Pull
Also Available

18in. CC

Metro Product Data

Collection Material: Zinc

CC	Product Type	Length	Width	Height/Projection	Hand Clearance	Diameter	Base	Tap/Screws (Qty)
*18in.	Appliance Pull	18 1/4in.	1 1/16in.	2 3/32in.	1 29/64in.	-	23/32in.	10-24 x 1in. (2)
*320mm	Pull	13in.	7/16in.	1 3/8in.	59/64in.	-	3/8in.	8-32 x 1in. (2)
224mm	Pull	9 1/4in.	7/16in.	1 3/8in.	59/64in.	-	3/8in.	8-32 x 1in. (2)
160mm	Pull	6 1 1/8in.	7/16in.	1 3/8in.	29/32in.	-	3/8in.	8-32 x 1in. (2)
128mm	Pull	5 7/16in.	7/16in.	1 3/8in.	29/32in.	-	3/8in.	8-32 x 1in. (2)
96mm	Pull	4 3/16in.	7/16in.	1 3/8in.	29/32in.	-	3/8in.	8-32 x 1in. (2)
-	Knob	1 3/16in.	1 3/16in.	1 1/4in.	3 1/2in.	-	5/16in.	8-32 x 1in. (1)

*Product not shown, please visit BerensonHardware.com to view images and details.

Metro Available Finishes, Sizes & Part Numbers

Handle Underside: Curved

+2 Additional 8-32 x 1 3/4in. break-off screws provided for pulls. 1 Additional 8-32 x 1 3/4in. break-off screw provided for knob.

NEW Finish
now available



BRUSHED NICKEL

18in. CC	9860-1BPN-P
320mm CC	9857-1BPN-P
224mm CC	9828-1BPN-P
160mm CC	4118-1BPN-P
128mm CC	4113-1BPN-P
96mm CC	4108-1BPN-P
Knob	4122-1BPN-P



MATTE BLACK

18in. CC	9861-1055-P
320mm CC	9859-1055-P
224mm CC	9858-1055-P
160mm CC	+4121-1055-P
128mm CC	4116-1055-P
96mm CC	+4111-1055-P
Knob	+4126-1055-P



MODERN BRUSHED GOLD

18in. CC	9912-1MDB-P
320mm CC	9902-1MDB-P
224mm CC	9901-1MDB-P
160mm CC	9899-1MDB-P
128mm CC	9898-1MDB-P
96mm CC	9897-1MDB-P
Knob	9903-1MDB-P



POLISHED CHROME

18in. CC	9916-1026-P
320mm CC	9905-1026-P
224mm CC	9904-1026-P
160mm CC	4119-1026-P
128mm CC	4114-1026-P
96mm CC	4109-1026-P
Knob	4124-1026-P



POLISHED COPPER

18in. CC	Not Available
320mm CC	4184-10PC-P
224mm CC	4183-10PC-P
160mm CC	4182-10PC-P
128mm CC	4181-10PC-P
96mm CC	4180-10PC-P
Knob	4185-10PC-P



SLATE

18in. CC	9973-1SLT-P
320mm CC	9970-1SLT-P
224mm CC	9909-1SLT-P
160mm CC	9908-1SLT-P
128mm CC	9907-1SLT-P
96mm CC	9906-1SLT-P
Knob	9971-1SLT-P



TOASTED BRONZE

18in. CC	Not Available
320mm CC	4190-10TB-P
224mm CC	4189-10TB-P
160mm CC	4188-10TB-P
128mm CC	4187-10TB-P
96mm CC	4191-10TB-P
Knob	4192-10TB-P

Featuring the Radial Reign Collection
in Modern Brushed Gold



RADIAL REIGN

UPTOWN APPEAL - Contemporary Style

Collection Featured in Matte Black and Modern Brushed Gold



Enlarged to show texture

Appliance Pulls Also Available
18in. CC & 12in. CC

Radial Reign Product Data

Collection Material: Aluminum

CC	Product Type	Length	Width	Height/Projection	Hand Clearance	Diameter	Base	Tap/Screws (Qty)
*18in.	Appliance Pull	21 1/2in.	1 1/2in.	2 7/8in.	1 3/8in.	-	1 1/2in.	10-24 x 1in. (2)
*12in.	Appliance Pull	14 3/8in.	2 3/8in.	1 7/8in.	1 3/8in.	-	1 1/2in.	10-24 x 1in. (2)
224mm	Pull	11 3/8in.	2 3/8in.	1 7/8in.	1 3/8in.	-	1 1/2in.	8-32 x 1in. (2)
160mm	Pull	8 2 1/2in.	2 3/8in.	1 7/8in.	1 3/8in.	-	1 1/2in.	8-32 x 1in. (2)
128mm	Pull	7 1 3/8in.	2 3/8in.	1 7/8in.	1 3/8in.	-	1 1/2in.	8-32 x 1in. (2)
96mm	Pull	6 3/8in.	2 3/8in.	1 7/8in.	1 3/8in.	-	1 1/2in.	8-32 x 1in. (2)
-	Knob	2in.	2 3/8in.	1 7/8in.	1 3/8in.	-	1 1/2in.	8-32 x 1in. (1)

*Product not shown, please visit BerensonHardware.com to view images and details.

71 | CC = center to center | images of parts are not shown at 100% scale

screw offering subject to change

Radial Reign Available Finishes, Sizes & Part Numbers

Handle Underside: Curved

NEW
18in. CC Length
coming spring 2024



BLACK NICKEL DESIGNER'S CHOICE

18in. CC	Not Available
12in. CC	5077-4098-P
224mm CC	5076-4098-P
160mm CC	5075-4098-P
128mm CC	5074-4098-P
96mm CC	5073-4098-P
Knob	5072-4098-P



BRUSHED NICKEL

18in. CC	5136-4BPN-P
12in. CC	5029-4BPN-P
224mm CC	5028-4BPN-P
160mm CC	5027-4BPN-P
128mm CC	5026-4BPN-P
96mm CC	5025-4BPN-P
Knob	5024-4BPN-P



BRUSHED NICKEL AND MATTE BLACK

18in. CC	Not Available
12in. CC	5071-4BPN55-P
224mm CC	5070-4BPN55-P
160mm CC	5069-4BPN55-P
128mm CC	5068-4BPN55-P
96mm CC	5067-4BPN55-P
Knob	5066-4BPN55-P



MATTE BLACK

18in. CC	5137-4055-P
12in. CC	5041-4055-P
224mm CC	5040-4055-P
160mm CC	5039-4055-P
128mm CC	5038-4055-P
96mm CC	5037-4055-P
Knob	5036-4055-P



MATTE BLACK AND BRUSHED NICKEL

18in. CC	5140-455BPN-P
12in. CC	5065-455BPN-P
224mm CC	5064-455BPN-P
160mm CC	5063-455BPN-P
128mm CC	5062-455BPN-P
96mm CC	5061-455BPN-P
Knob	5060-455BPN-P



MATTE BLACK AND MODERN BRUSHED GOLD

18in. CC	5138-455MDB-P
12in. CC	5059-455MDB-P
224mm CC	5058-455MDB-P
160mm CC	5057-455MDB-P
128mm CC	5056-455MDB-P
96mm CC	5055-455MDB-P
Knob	5054-455MDB-P



MODERN BRUSHED GOLD

18in. CC	5139-4MDB-P
12in. CC	5053-4MDB-P
224mm CC	5052-4MDB-P
160mm CC	5051-4MDB-P
128mm CC	5050-4MDB-P
96mm CC	5049-4MDB-P
Knob	5048-4MDB-P



POLISHED CHROME

18in. CC	Not Available
12in. CC	5035-4026-P
224mm CC	5034-4026-P
160mm CC	5033-4026-P
128mm CC	5032-4026-P
96mm CC	5031-4026-P
Knob	5030-4026-P



SLATE

18in. CC	Not Available
12in. CC	5047-4SLT-P
224mm CC	5046-4SLT-P
160mm CC	5045-4SLT-P
128mm CC	5044-4SLT-P
96mm CC	5043-4SLT-P
Knob	5042-4SLT-P



Appliance Pull
Also Available
12in. CC

Roque Product Data

Collection Material: Zinc

CC	Product Type	Length	Width	Height/Projection	Hand Clearance	Diameter	Base	Tap/Screws (Qty)
*12in.	Appliance Pull	12 1/2in.	2 5/8in.	1 1/2in.	2 5/8in.	-	1 5/8in.	10-24 x 1in. (2)
224mm	Pull	9 3/4in.	2 3/8in.	1 1/4in.	7/8in.	-	7/16in.	8-32 x 1in. (2)
160mm	Pull	6 2 3/8in.	2 1/8in.	1 7/8in.	2 7/8in.	-	1 3/8in.	8-32 x 1in. (2)
128mm	Pull	5 1/4in.	2 1/8in.	1 7/8in.	2 7/8in.	-	1 3/8in.	8-32 x 1in. (2)
96mm	Pull	4 3/4in.	2 1/8in.	1 7/8in.	2 5/8in.	-	1 3/8in.	8-32 x 1in. (2)
-	Knob	1 3/16in.	1 3/16in.	1 7/8in.	2 5/8in.	-	1 3/8in.	8-32 x 1in. (1)

*Product not shown, please visit BerensonHardware.com to view images and details.

Roque Available Finishes, Sizes & Part Numbers

Handle Underside: Curved

NEW
Collection
now available



BLACK NICKEL

12in. CC	8125-1098-P
224mm CC	8124-1098-P
160mm CC	8123-1098-P
128mm CC	8122-1098-P
96mm CC	8121-1098-P
Knob	8120-1098-P



BRUSHED NICKEL

12in. CC	8101-1BPN-P
224mm CC	8100-1BPN-P
160mm CC	8099-1BPN-P
128mm CC	8098-1BPN-P
96mm CC	8097-1BPN-P
Knob	8096-1BPN-P



MATTE BLACK

12in. CC	8095-1055-P
224mm CC	8094-1055-P
160mm CC	8093-1055-P
128mm CC	8092-1055-P
96mm CC	8091-1055-P
Knob	8090-1055-P



MODERN BRUSHED GOLD

12in. CC	8107-1MDB-P
224mm CC	8106-1MDB-P
160mm CC	8105-1MDB-P
128mm CC	8104-1MDB-P
96mm CC	8103-1MDB-P
Knob	8102-1MDB-P



POLISHED CHROME

12in. CC	8119-1026-P
224mm CC	8118-1026-P
160mm CC	8117-1026-P
128mm CC	8116-1026-P
96mm CC	8115-1026-P
Knob	8114-1026-P



VINTAGE NICKEL

12in. CC	8113-1VTN-P
224mm CC	8112-1VTN-P
160mm CC	8111-1VTN-P
128mm CC	8110-1VTN-P
96mm CC	8109-1VTN-P
Knob	8108-1VTN-P

SKYLINE

UPTOWN APPEAL - Contemporary Style

Collection Featured in Slate



Skyline Available Finishes, Sizes & Part Numbers

Handle Underside: Flat



BRUSHED NICKEL

320mm CC	9974-1BPN-P
224mm CC	9206-1BPN-P
160mm CC	9203-1BPN-P
3in. & 96mm CC	9200-1BPN-P
Knob	9209-1BPN-P



MATTE BLACK

320mm CC	9975-1055-P
224mm CC	9208-1055-P
160mm CC	9205-1055-P
3in. & 96mm CC	9202-1055-P
Knob	9211-1055-P

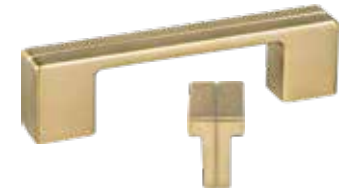

MODERN BRUSHED GOLD

320mm CC	9993-1MDB-P
224mm CC	9978-1MDB-P
160mm CC	9977-1MDB-P
3in. & 96mm CC	9976-1MDB-P
Knob	9995-1MDB-P



POLISHED CHROME

320mm CC	1120-1026-P
224mm CC	9207-1026-P
160mm CC	9204-1026-P
3in. & 96mm CC	9201-1026-P
Knob	9210-1026-P



SLATE

320mm CC	1124-1SLT-P
224mm CC	1123-1SLT-P
160mm CC	1122-1SLT-P
3in. & 96mm CC	1121-1SLT-P
Knob	1125-1SLT-P

Skyline Product Data

Collection Material: Zinc

CC	Product Type	Length	Width	Height/Projection	Hand Clearance	Diameter	Base	Tap/Screws (Qty)
*320mm	Pull	13in.	5/8in.	1 1/2in.	7/8in.	-	1 3/8in.	8-32 x 1in. (2)
224mm	Pull	9 1/4in.	5/8in.	1 1/2in.	7/8in.	-	1 3/8in.	8-32 x 1in. (2)
160mm	Pull	6 1/2in.	5/8in.	1 1/2in.	7/8in.	-	1in.	8-32 x 1in. (2)
3in. & 96mm	Pull	4 3/4in.	5/8in.	1 1/2in.	7/8in.	-	1 3/8in.	8-32 x 1in. (2)
-	Knob	1 3/8in.	3/4in.	1 1/2in.	4 3/4in.	-	3/8in.	8-32 x 1in. (1)

*Product not shown, please visit BerensonHardware.com to view images and details.

STAINLESS STEEL

UPTOWN APPEAL - Contemporary Style

Collection Only Available in Stainless Steel Finish

Handle Underside: Curved

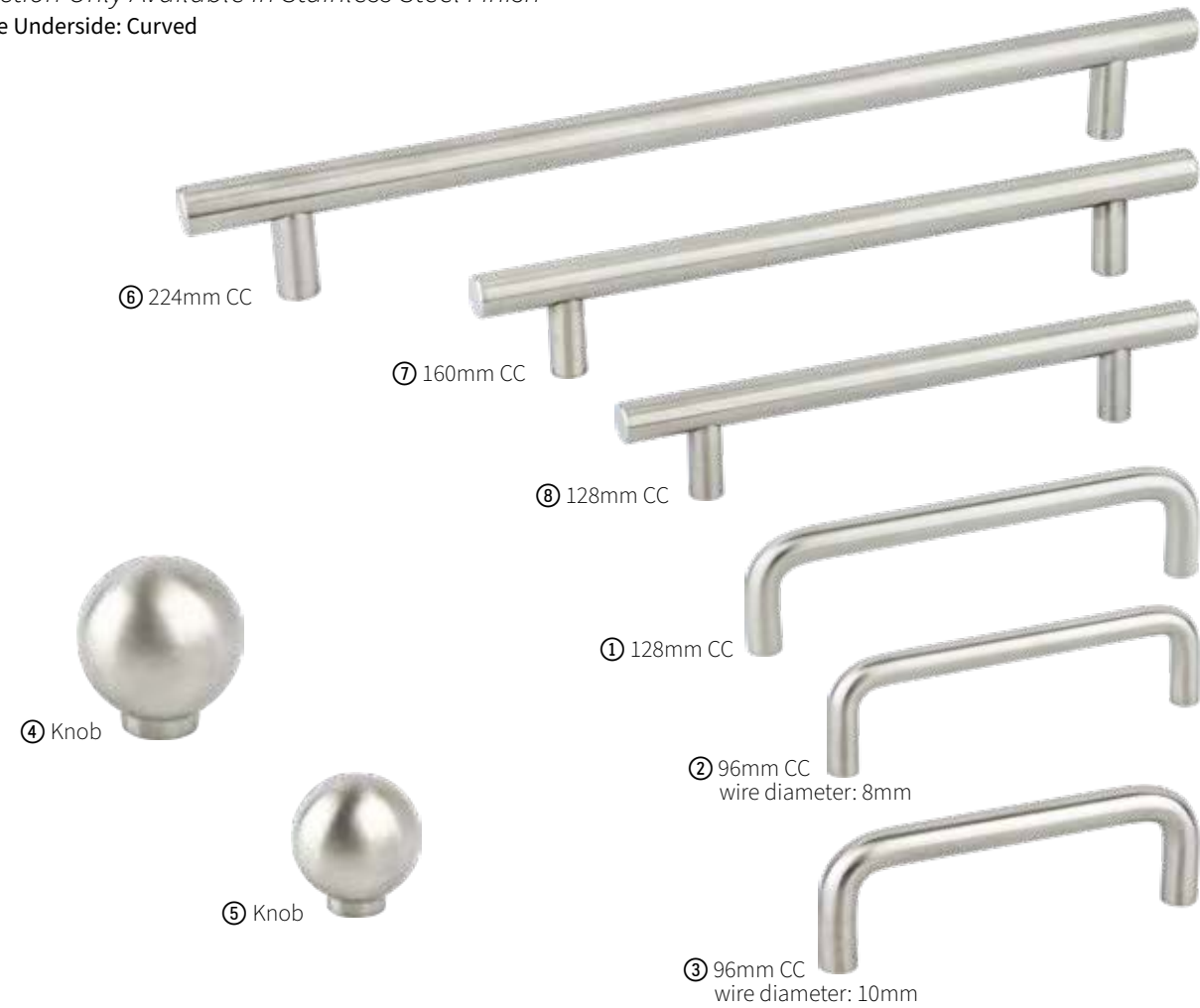

Stainless Steel Product Data – GRADE 304

Collection Material: Stainless Steel

	Part No.	CC	Product Type	Length	Width	Height/Projection	Hand Clearance	Diameter	Base	Tap/Screws (Qty)
	7067-9SS-C	*672mm	Pull	28 3/8in.	1/2in.	1 1/4in.	1 3/8in.	-	1/2in.	M4 x 45mm BO (3)
	7073-9SS-C	*448mm	Pull	19 7/8in.	1/2in.	1 1/4in.	1 3/8in.	-	1/2in.	M4 x 45mm BO (2)
	7072-9SS-C	*384mm	Pull	17 1/2in.	1/2in.	1 1/4in.	1 3/8in.	-	1/2in.	M4 x 45mm BO (2)
	7071-9SS-C	*288mm	Pull	13 3/4in.	1/2in.	1 1/4in.	1 3/8in.	-	1/2in.	M4 x 45mm BO (2)
	7077-9SS-C	*288mm	Pull	11 3/4in.	3/8in.	1 3/8in.	1 1/4in.	-	3/8in.	M4 x 45mm BO (2)
1	7076-9SS-C	128mm	Pull	5 7/8in.	3/8in.	1 3/8in.	1 1/4in.	-	3/8in.	M4 x 45mm BO (2)
2	7074-9SS-C	96mm	Pull	4 1/2in.	3/8in.	1 1/4in.	7/8in.	-	3/8in.	M4 x 45mm BO (2)
3	7075-9SS-C	96mm	Pull	4 3/8in.	3/8in.	1 3/8in.	1 1/4in.	-	3/8in.	M4 x 45mm BO (2)
4	7078-9SS-C	-	Knob	-	-	1 1/4in.	-	1 3/8in.	3/8in.	M4 x 45mm BO (1)
5	7079-9SS-C	-	Knob	-	-	1 1/4in.	-	1in.	7/8in.	M4 x 45mm BO (1)
6	7070-9SS-C	224mm	Pull	10 1 3/8in.	1/2in.	1 1/4in.	1 3/8in.	-	1/2in.	M4 x 45mm BO (2)
7	7069-9SS-C	160mm	Pull	8 1/4in.	1/2in.	1 1/4in.	1 3/8in.	-	1/2in.	M4 x 45mm BO (2)
8	7068-9SS-C	128mm	Pull	7in.	1/2in.	1 1/4in.	1 3/8in.	-	1/2in.	M4 x 45mm BO (2)

*Product not shown, please visit BerensonHardware.com to view images and details.

■ Part is hollow.

77 | CC = center to center | images of parts are not shown at 100% scale | BO = break off screw

STUDIO

UPTOWN APPEAL - Contemporary Style

Collection Only Available in Stainless Steel Finish

Handle Underside: Curved



Studio Product Data

Collection Material: Stainless Steel

	Part No.	CC	Product Type	Length	Width	Height/Projection	Hand Clearance	Diameter	Base	Tap/Screws (Qty)
	2027-90SS-P	*576mm	Pull	23 1/4in.	3/8in.	1 7/8in.	7/8in.	-	7/8in.	8-32 x 1in. (2)
	2026-90SS-P	*288mm	Pull	11 7/8in.	3/8in.	1 7/8in.	7/8in.	-	7/8in.	8-32 x 1in. (2)
	2025-90SS-P	256mm	Pull	10 5/8in.	3/8in.	1 7/8in.	7/8in.	-	7/8in.	8-32 x 1in. (2)
	2024-90SS-P	224mm	Pull	9 3/8in.	3/8in.	1 7/8in.	7/8in.	-	7/8in.	8-32 x 1in. (2)
	2023-90SS-P	192mm	Pull	8 1/2in.	3/8in.	1 7/8in.	7/8in.	-	7/8in.	8-32 x 1in. (2)
	2022-90SS-P	160mm	Pull	6 7/8in.	3/8in.	1 7/8in.	7/8in.	-	7/8in.	8-32 x 1in. (2)
	2021-90SS-P	128mm	Pull	5 5/8in.	3/8in.	1 7/8in.	7/8in.	-	7/8in.	8-32 x 1in. (2)

*Product not shown, please visit BerensonHardware.com to view images and details.

■ Part is hollow.

CC = center to center | images of parts are not shown at 100% scale

BerensonHardware.com | 78



Appliance Pull
Also Available

18in. CC

Knob
has tooth at bottom to
help secure in position

Swagger Product Data

Collection Material: Zinc

CC	Product Type	Length	Width	Height/Projection	Hand Clearance	Diameter	Base	Tap/Screws (Qty)
18in.	Appliance Pull	18 2 ³ / ₂ in.	2 ⁷ / ₂ in.	1 2 ³ / ₂ in.	1 1 ¹ / ₂ in.	-	2 ³ / ₂ in.	10-24 x 1in. (2)
*320mm	Pull	13 1 ¹ / ₂ in.	5 ¹ / ₂ in.	1 1 ¹ / ₂ in.	1 ⁵ / ₁₆ in.	-	1/2in.	8-32 x 1in. (2)
224mm	Pull	9 1 ¹ / ₂ in.	5 ¹ / ₂ in.	1 1 ¹ / ₂ in.	1 ⁵ / ₁₆ in.	-	1/2in.	8-32 x 1in. (2)
160mm	Pull	6 3 ¹ / ₂ in.	5 ¹ / ₂ in.	1 1 ¹ / ₂ in.	1 ⁵ / ₁₆ in.	-	1/2in.	8-32 x 1in. (2)
128mm	Pull	5 1 ¹ / ₂ in.	5 ¹ / ₂ in.	1 1 ¹ / ₂ in.	1 ⁵ / ₁₆ in.	-	1/2in.	8-32 x 1in. (2)
96mm	Pull	4 3 ¹ / ₂ in.	5 ¹ / ₂ in.	1 1 ¹ / ₂ in.	1 ⁵ / ₁₆ in.	-	1/2in.	8-32 x 1in. (2)
-	Knob	1 3 ¹ / ₂ in.	1 3 ¹ / ₂ in.	1 1 ¹ / ₂ in.	7 ¹ / ₁₆ in.	-	7 ¹ / ₁₆ in.	8-32 x 1in. (1)

*Product not shown, please visit BerensonHardware.com to view images and details.

Swagger Available Finishes, Sizes & Part Numbers

Handle Underside: Flat

NEW
18in. CC Length
now available



BLACK NICKEL

18in. CC	2416-1098-P
320mm CC	2323-1098-P
224mm CC	2320-1098-P
160mm CC	2317-1098-P
128mm CC	2314-1098-P
96mm CC	2385-1098-P
Knob	2326-1098-P



BRUSHED NICKEL

18in. CC	2413-1BPN-P
320mm CC	2321-1BPN-P
224mm CC	2318-1BPN-P
160mm CC	2315-1BPN-P
128mm CC	2312-1BPN-P
96mm CC	2386-1BPN-P
Knob	2324-1BPN-P



MATTE BLACK

18in. CC	2417-1055-P
320mm CC	2411-1055-P
224mm CC	2398-1055-P
160mm CC	2397-1055-P
128mm CC	2396-1055-P
96mm CC	2395-1055-P
Knob	2394-1055-P



MODERN BRUSHED GOLD

18in. CC	2415-1MDB-P
320mm CC	2367-1MDB-P
224mm CC	2366-1MDB-P
160mm CC	2365-1MDB-P
128mm CC	2364-1MDB-P
96mm CC	2387-1MDB-P
Knob	2368-1MDB-P



POLISHED CHROME

18in. CC	Not Available
320mm CC	2322-1026-P
224mm CC	2319-1026-P
160mm CC	2316-1026-P
128mm CC	2313-1026-P
96mm CC	2388-1026-P
Knob	2325-1026-P



SLATE

18in. CC	Not Available
320mm CC	2412-1SLT-P
224mm CC	2393-1SLT-P
160mm CC	2392-1SLT-P
128mm CC	2391-1SLT-P
96mm CC	2390-1SLT-P
Knob	2389-1SLT-P



TIMELESS *CHARM*

Traditional Style

Bring strength & grace through classic hardware designs to reach an inviting, timeless impact.

Featuring the Hearthstone Collection
in Matte Black

AMERICAN CLASSICS

TIMELESS CHARM - Traditional Style

Collection Featured in Rubbed Bronze



American Classics Product Data

Collection Material: Zinc

	CC	Product Type	Length	Width	Height/Projection	Hand Clearance	Diameter	Base	Tap/Screws (Qty)
1	3in.	Pull	3 1/4in.	3/4in.	1 1/4in.	7/8in.	-	5/8in.	8-32 x 1in. (2)
2	3in.	Cup Pull	4 1/4in.	1 7/8in.	1 5/8in.	5 3/4in.	-	-	8-32 x 1in. (2)
3	-	Knob	1 3/4in.	7/8in.	1 1/4in.	-	-	5/8in.	8-32 x 1in. (1)
4	-	Knob	-	-	1 1/4in.	3 5/8in.	1 3/4in.	5/8in.	8-32 x 1in. (1)
5	-	Knob	-	-	1in.	4 9/16in.	1 1/8in.	5/8in.	+8-32 x 1in. (1)

American Classics Available Finishes, Sizes & Part Numbers

Handle Underside: Curved

+1 Additional 8-32 x 1 3/4in. break-off screw provided.



BRUSHED NICKEL

3in. CC Pull	9886-1BPN-P
3in. CC Cup Pull	9896-1BPN-P
③ Knob	9937-1BPN-P
④ Knob	9079-1BPN-P
⑤ Knob	+9924-1BPN-P



DULL RUST

3in. CC Pull	9887-1FE-P
3in. CC Cup Pull	9892-1FE-P
③ Knob	9934-1FE-P
④ Knob	2055-1FE-P
⑤ Knob	Not Available



RUBBED BRONZE

3in. CC Pull	9885-110-P
3in. CC Cup Pull	9890-110-P
③ Knob	9933-110-P
④ Knob	9938-110-P
⑤ Knob	9923-110-P



WEATHERED COPPER

3in. CC Pull	9889-1WC-P
3in. CC Cup Pull	9893-1WC-P
③ Knob	9935-1WC-P
④ Knob	9941-1WC-P
⑤ Knob	9925-1WC-P



WEATHERED NICKEL

3in. CC Pull	9888-1WN-P
3in. CC Cup Pull	9895-1WN-P
③ Knob	9936-1WN-P
④ Knob	9942-1WN-P
⑤ Knob	9927-1WN-P

ANDANTE

TIMELESS CHARM - *Traditional Style*

Collection Featured in Antique Pewter



Andante Available Finishes, Sizes & Part Numbers

The cup pulls of this collection feature a curved underside on the handle.

+2 Additional 8-32 x 1 3/4 in. break-off screws provided.



ANTIQUÉ PEWTER

128mm CC	+3011-1AP-P
96mm CC	7888-1AP-P
64mm CC	+3012-1AP-P
Knob	7893-1AP-P



BRUSHED NICKEL

128mm CC	7881-1BPN-P
96mm CC	+3014-1BPN-P
64mm CC	7884-1BPN-P
Knob	7891-1BPN-P



DULL BRONZE

128mm CC	+3008-1DBZ-P
96mm CC	7889-1DBZ-P
64mm CC	+3009-1DBZ-P
Knob	7894-1DBZ-P

Andante Product Data

Collection Material: Zinc

CC	Product Type	Length	Width	Height/Projection	Hand Clearance	Diameter	Base	Tap/Screws (Qty)
128mm	Pull	5 1/4 in.	5/8 in.	1 1/4 in.	5/8 in.	-	5/8 in.	8-32 x 1 in. (2)
96mm	Pull	4 1/4 in.	1 1/4 in.	1 1/4 in.	5/8 in.	-	1 1/4 in.	8-32 x 1 in. (2)
64mm	Cup Pull	4 1/4 in.	1 1/4 in.	1 in.	7/8 in.	-	-	8-32 x 1 in. (2)
-	Knob	-	-	1 in.	1 1/4 in.	1 3/4 in.	1 in.	8-32 x 1 in. (1)

Faux screws and buttons add a classically rustic charm.





Featuring the Echo Collection in Brushed Nickel
 Design and photos by Jennifer Hutton at
 Artisan Kitchens and Baths,
 @JenniferHutton_Pro



ECHO

TIMELESS CHARM - Traditional Style

Collection Featured in Matte Black



Knob

96mm CC

3in. CC

Echo Available Finishes, Sizes & Part Numbers

Handle Underside: Flat



BRUSHED NICKEL

96mm CC	9225-1BPN-P
3in. CC	9222-1BPN-P
Knob	9228-1BPN-P



MATTE BLACK

96mm CC	9261-1055-P
3in. CC	9260-1055-P
Knob	9262-1055-P



OIL RUBBED BRONZE

96mm CC	9224-1ORB-P
3in. CC	9221-1ORB-P
Knob	9227-1ORB-P



POLISHED NICKEL

96mm CC	9258-1014-P
3in. CC	9257-1014-P
Knob	9259-1014-P



VERONA BRONZE

96mm CC	9226-10VB-P
3in. CC	9223-10VB-P
Knob	9229-10VB-P

Echo Product Data

Collection Material: Zinc

CC	Product Type	Length	Width	Height/Projection	Hand Clearance	Diameter	Base	Tap/Screws (Qty)
96mm	Pull	5 5/8in.	3/4in.	1 1/4in.	6 3/4in.	-	1 1/2in.	8-32 x 1in. (2)
3in.	Pull	4 3/4in.	3/4in.	1 1/4in.	1 5/8in.	-	1in.	8-32 x 1in. (2)
-	Knob	-	-	1 3/8in.	-	1 3/8in.	5/8in.	8-32 x 1in. (1)

CC = center to center | images of parts are not shown at 100% scale

EURO TRADITIONS

TIMELESS CHARM - *Traditional Style*

Collection Featured in Brushed Antique Copper



Euro Traditions Available Finishes, Sizes & Part Numbers

Handle Underside: Flat



BRUSHED ANTIQUE COPPER

96mm CC	2933-1BAC-P
Knob	2923-1BAC-P



BRUSHED ANTIQUE PEWTER

96mm CC	2934-1BAP-P
Knob	2924-1BAP-P



BRUSHED BLACK NICKEL

96mm CC	2931-1BBN-P
Knob	2921-1BBN-P



BRUSHED NICKEL

96mm CC	2930-1BPN-P
Knob	2920-1BPN-P



DULL RUST

96mm CC	2938-1FE-P
Knob	2928-1FE-P



MATTE BLACK

96mm CC	2937-155-P
Knob	2927-155-P

Euro Traditions Product Data

Collection Material: Zinc

CC	Product Type	Length	Width	Height/Projection	Hand Clearance	Diameter	Base	Tap/Screws (Qty)
96mm	Pull	4 3/8in.	3/4in.	1 1/8in.	5/8in.	-	3/8in.	8-32 x 1in. (2)
-	Knob	-	-	1 1/8in.	3/8in.	1 3/8in.	3/8in.	8-32 x 1 1/8in. (1)

HARMONY

TIMELESS CHARM - *Traditional Style*

Collection Featured in Vintage Nickel



Harmony Available Finishes, Sizes & Part Numbers

Handle Underside: Flat



BRUSHED NICKEL

160mm CC	9456-1BPN-P
128mm CC	9450-1BPN-P
96mm CC	9444-1BPN-P
3in. CC	9438-1BPN-P
Knob	9462-1BPN-P



VERONA BRONZE

160mm CC	9455-10VB-P
128mm CC	9449-10VB-P
96mm CC	9443-10VB-P
3in. CC	9437-10VB-P
Knob	9461-10VB-P



VINTAGE NICKEL

160mm CC	9579-1VTN-P
128mm CC	9578-1VTN-P
96mm CC	9577-1VTN-P
3in. CC	9576-1VTN-P
Knob	9580-1VTN-P



WEATHERED NICKEL

160mm CC	9454-10WN-P
128mm CC	9448-10WN-P
96mm CC	9442-10WN-P
3in. CC	9436-10WN-P
Knob	9460-10WN-P

Harmony Product Data

Collection Material: Zinc

CC	Product Type	Length	Width	Height/Projection	Hand Clearance	Diameter	Base	Tap/Screws (Qty)
160mm	Pull	6 7/8in.	1 1/8in.	1 1/8in.	5/8in.	-	3/8in.	8-32 x 1 1/8in. (2)
128mm	Pull	5 11/16in.	1 1/8in.	1 1/8in.	5/8in.	-	3/8in.	8-32 x 1 1/8in. (2)
96mm	Pull	4 7/8in.	1 1/8in.	1 1/8in.	5/8in.	-	3/8in.	8-32 x 1 1/8in. (2)
3in.	Pull	3 11/16in.	1 1/8in.	1 1/8in.	5/8in.	-	3/8in.	8-32 x 1 1/8in. (2)
-	Knob	1 3/8in.	1 3/8in.	1 1/8in.	13/16in.	-	3/8in.	8-32 x 1 1/8in. (1)

Parts in the Harmony Collection feature removable inserts that can be interchanged with other parts of the same length to create a unique mixed metal piece. Please note that pieces do not come as mixed metal. Hardware must be purchased separately and mixed as needed for design.

HEARTHSTONE

TIMELESS CHARM - Traditional Style

Collection Featured in Matte Black



Appliance Pulls Also Available

18in. CC & 12in. CC

Hearthstone Product Data

Collection Material: Zinc

CC	Product Type	Length	Width	Height/Projection	Hand Clearance	Diameter	Base	Tap/Screws (Qty)
*18in.	Appliance Pull	19 1/4in.	1 1/4in.	1 3/8in.	1 3/8in.	-	1 3/8in.	10-24 x 1in. (2)
*12in.	Appliance Pull	13 3/4in.	3/4in.	1 13/16in.	1 23/64in.	-	1 1/4in.	10-24 x 1in. (2)
**6in.	Pull	7 3/8in.	1 1/2in.	1 11/16in.	1 53/32in.	-	1 1/8in.	8-32 x 1in. (2)
160mm	Pull	7 1/2in.	5/8in.	1 1/2in.	1 23/64in.	-	7/8in.	8-32 x 1in. (2)
128mm	Pull	6 1/2in.	1/2in.	1 7/8in.	1 1/64in.	-	7/8in.	8-32 x 1in. (2)
96mm	Pull	4 13/16in.	3/8in.	1 3/8in.	63/64in.	-	7/8in.	8-32 x 1in. (2)
3in.	Pull	3 13/16in.	3/8in.	1 3/8in.	63/64in.	-	13/16in.	8-32 x 1in. (2)
-	Knob	1 1/8in.	1 1/8in.	1 1/8in.	3/4in.	-	13/16in.	8-32 x 1in. (1)

*Product not shown, please visit BerensonHardware.com to view images and details.

**The 6in. CC pull features a wider width that adds dimension to kitchen and bath designs.

Hearthstone Available Finishes, Sizes & Part Numbers

Handle Underside: Semi-Curved

See Designers' Group Ten collection on pages 25-26 to view the Polished Nickel finish.



BRUSHED NICKEL

18in. CC	2168-1BPN-P
12in. CC	2035-1BPN-P
6in. CC	4076-1BPN-P
160mm CC	2045-1BPN-P
128mm CC	2040-1BPN-P
96mm CC	4070-1BPN-P
3in. CC	4064-1BPN-P
Knob	4083-1BPN-P



MATTE BLACK

18in. CC	2169-1055-P
12in. CC	2038-1055-P
6in. CC	4080-1055-P
160mm CC	2048-1055-P
128mm CC	2043-1055-P
96mm CC	4074-1055-P
3in. CC	4068-1055-P
Knob	4086-1055-P



MODERN BRUSHED GOLD

18in. CC	2157-1MDB-P
12in. CC	2156-1MDB-P
6in. CC	2155-1MDB-P
160mm CC	2154-1MDB-P
128mm CC	2153-1MDB-P
96mm CC	2152-1MDB-P
3in. CC	2151-1MDB-P
Knob	2158-1MDB-P



VERONA BRONZE

18in. CC	2167-10VB-P
12in. CC	2034-10VB-P
6in. CC	4075-10VB-P
160mm CC	2044-10VB-P
128mm CC	2039-10VB-P
96mm CC	4069-10VB-P
3in. CC	4063-10VB-P
Knob	4081-10VB-P



VINTAGE NICKEL

18in. CC	2165-1VTN-P
12in. CC	2164-1VTN-P
6in. CC	2163-1VTN-P
160mm CC	2162-1VTN-P
128mm CC	2161-1VTN-P
96mm CC	2160-1VTN-P
3in. CC	2159-1VTN-P
Knob	2166-1VTN-P



WEATHERED VERONA BRONZE

18in. CC	Not Available
12in. CC	2037-1WVB-P
6in. CC	4079-1WVB-P
160mm CC	2047-1WVB-P
128mm CC	2042-1WVB-P
96mm CC	4073-1WVB-P
3in. CC	4067-1WVB-P
Knob	4085-1WVB-P

HILLCREST

TIMELESS CHARM - *Traditional Style*

Collection Featured in Verona Bronze



Appliance Pull
Also Available

256mm CC

Hillcrest Available Finishes, Sizes & Part Numbers

Handle Underside: Curved



BRUSHED NICKEL

256mm CC	2073-1BPN-P
160mm CC	2071-1BPN-P
128mm CC	2069-1BPN-P
96mm CC	2049-1BPN-P

VERONA BRONZE

256mm CC	2074-10VB-P
160mm CC	2072-10VB-P
128mm CC	2070-10VB-P
96mm CC	2068-10VB-P

Hillcrest Product Data

Collection Material: Zinc

CC	Product Type	Length	Width	Height/Projection	Hand Clearance	Diameter	Base	Tap/Screws (Qty)
*256mm	Appliance Pull	12in.	1 3/16in.	1 13/16in.	1 7/16in.	-	1 3/16in.	10-24 x 1in. (2)
160mm	Pull	7 7/8in.	5/8in.	1 1/2in.	7/8in.	-	7/8in.	8-32 x 1in. (2)
128mm	Pull	6 5/8in.	5/8in.	1 1/2in.	53/64in.	-	7/8in.	8-32 x 1in. (2)
96mm	Pull	5 3/8in.	9/16in.	1 1/2in.	23/32in.	-	7/8in.	8-32 x 1in. (1)

*Product not shown, please visit BerensonHardware.com to view images and details.

PRELUDE

TIMELESS CHARM — *Traditional Style*

Collection Available in All Finishes Shown

NEW
Finishes
now available

Prelude Available Finishes, Sizes & Part Numbers



BRUSHED NICKEL

4in. 8012-BPN-P



MATTE BLACK

4in. 8014-55-P



MODERN BRUSHED GOLD

4in. 8018-MDB-P



OIL RUBBED BRONZE

4in. 8015-ORB-P



POLISHED CHROME

4in. 8011-26-P



VERONA BRONZE

4in. 8016-VB-P



VINTAGE NICKEL

4in. 8019-VTN-P



WEATHERED NICKEL

4in. 8013-WN-P

Prelude Product Data

Collection Material: Zinc

CC	Product Type	Length	Width	Height/Projection	Hand Clearance	Diameter	Base	Screws (Qty)
-	Hook	4in.	3/8in.	3 1/2in.	-	-	1 1/2in.	5/8in. Wood (4)



Featuring the Tailored Traditional Collection in Verona Bronze
Design and photos by Jennifer Hutton at
Artisan Kitchens and Baths,
@JenniferHutton_Pro

TAILORED TRADITIONAL

TIMELESS CHARM - Traditional Style

Collection Featured in Matte Black



Appliance Pull
Also Available
12in. CC

Tailored Traditional Product Data

Collection Material: Zinc

CC	Product Type	Length	Width	Height/Projection	Hand Clearance	Diameter	Base	Tap/Screws (Qty)
*12in.	Appliance Pull	13in.	1in.	1 1/16in.	1 1/8in.	-	1in.	10-24 x 1in. (2)
224mm	Pull	9 3/8in.	1 3/16in.	1 3/8in.	1in.	-	1 3/16in.	8-32 x 1in. (2)
160mm	Pull	7in.	1 1/16in.	1 3/8in.	1 1/4in.	-	1 1/16in.	8-32 x 1in. (2)
128mm	Pull	5 3/4in.	2 3/32in.	1 5/16in.	1 1/4in.	-	2 3/32in.	8-32 x 1in. (2)
96mm	Pull	4 1/2in.	2 3/32in.	1 5/16in.	1in.	-	2 3/32in.	8-32 x 1in. (2)
-	Knob	1 1/4in.	1 1/16in.	1 1/16in.	2 1/32in.	-	1 1/16in.	8-32 x 1in. (1)

*Product not shown, please visit BerensonHardware.com to view images and details.

Tailored Traditional Available Finishes, Sizes & Part Numbers

Handle Underside: Curved



BRUSHED NICKEL

12in. CC	1302-1BPN-P
224mm CC	1296-1BPN-P
160mm CC	1290-1BPN-P
128mm CC	1284-1BPN-P
96mm CC	1278-1BPN-P
Knob	1272-1BPN-P



MATTE BLACK

12in. CC	1305-1055-P
224mm CC	1299-1055-P
160mm CC	1293-1055-P
128mm CC	1287-1055-P
96mm CC	1281-1055-P
Knob	1275-1055-P



MODERN BRUSHED GOLD

12in. CC	1306-1MDB-P
224mm CC	1300-1MDB-P
160mm CC	1294-1MDB-P
128mm CC	1288-1MDB-P
96mm CC	1282-1MDB-P
Knob	1276-1MDB-P



POLISHED NICKEL

12in. CC	1304-1014-P
224mm CC	1298-1014-P
160mm CC	1292-1014-P
128mm CC	1286-1014-P
96mm CC	1280-1014-P
Knob	1274-1014-P



VERONA BRONZE

12in. CC	1303-10VB-P
224mm CC	1297-10VB-P
160mm CC	1291-10VB-P
128mm CC	1285-10VB-P
96mm CC	1279-10VB-P
Knob	1273-10VB-P



VINTAGE NICKEL

12in. CC	1307-1VTN-P
224mm CC	1301-1VTN-P
160mm CC	1295-1VTN-P
128mm CC	1289-1VTN-P
96mm CC	1283-1VTN-P
Knob	1277-1VTN-P



VESTED INTEREST

TIMELESS CHARM - *Traditional Style*

Collection Featured in Vintage Nickel



Knob
has tooth at bottom to help secure in position

Vested Interest Product Data

Collection Material: Zinc

CC	Product Type	Length	Width	Height/Projection	Hand Clearance	Diameter	Base	Tap/Screws (Qty)
*12in.	Appliance Pull	13 1/4in.	1/4in.	1 3/4in.	1 1/4in.	-	3/8in.	10-24 x 1in. (2)
224mm	Pull	9 3/4in.	3/4in.	1 3/8in.	1 1/4in.	-	5/8in.	8-32 x 1in. (2)
160mm	Pull	7 1/4in.	1 1/4in.	1 1/2in.	2 3/32in.	-	1/2in.	8-32 x 1in. (2)
128mm	Pull	6in.	5/8in.	1 3/4in.	5 5/64in.	-	1/2in.	8-32 x 1in. (2)
96mm	Pull	4 3/4in.	5/8in.	1 3/4in.	5 5/64in.	-	1/2in.	8-32 x 1in. (2)
-	Knob	-	-	1 5/8in.	4 1/64in.	1 1/4in.	1 1/8in.	8-32 x 1in. (1)

*Product not shown, please visit BerensonHardware.com to view images and details.

Vested Interest Available Finishes, Sizes & Part Numbers

Handle Underside: Flat



BRUSHED NICKEL

12in. CC	2335-1BPN-P
224mm CC	2333-1BPN-P
160mm CC	2331-1BPN-P
128mm CC	2329-1BPN-P
96mm CC	2327-1BPN-P
Knob	2337-1BPN-P



VERONA BRONZE

12in. CC	2336-10VB-P
224mm CC	2334-10VB-P
160mm CC	2332-10VB-P
128mm CC	2330-10VB-P
96mm CC	2328-10VB-P
Knob	2338-10VB-P



VINTAGE NICKEL

12in. CC	2373-1VTN-P
224mm CC	2372-1VTN-P
160mm CC	2371-1VTN-P
128mm CC	2370-1VTN-P
96mm CC	2369-1VTN-P
Knob	2374-1VTN-P



The segmented appearance creates a *layered style* that adds *dimension* to a cabinet.

VIBRATO

TIMELESS CHARM - Traditional Style

Collection Only Available in Verona Bronze



Vibrato Product Data

Collection Material: Zinc

	Part No.	CC	Product Type	Length	Width	Height/Projection	Hand Clearance	Diameter	Base	Tap/Screws (Qty)
1	7904-1VB-P	128mm	Pull	6 7/16in.	5/16in.	1 1/16in.	-	-	1/2in.	8-32 x 1in. (2)
2	7905-1VB-P	96mm	Pull	5 3/16in.	5/16in.	1 5/16in.	-	-	1/2in.	8-32 x 1in. (2)
3	7906-1VB-P	-	Knob	1 11/16in.	1/2in.	1 3/16in.	-	-	1/2in.	8-32 x 1in. (1)
4	7895-1VB-P	-	Knob	-	-	1in.	-	1 3/16in.	1in.	8-32 x 1in. (1)
5	7898-1VB-P	3in.	Pull	4 5/16in.	7/16in.	1 3/16in.	-	-	1/2in.	8-32 x 1in. (2)
6	7890-1VB-P	96mm	Pull	4 1 5/16in.	1 1/16in.	1 1/8in.	5 9/16in.	-	1 5/16in.	8-32 x 1in. (2)
7	7900-1VB-P	3in.	Pull	4 1 1/16in.	3/16in.	1 3/16in.	4 3/16in.	-	3/4in.	8-32 x 1in. (2)
8	8016-VB-P	-	Hook	4in.	3/8in.	3 1/16in.	-	-	1 1/16in.	5/16in. Wood (4)
9	7897-1VB-P	-	Knob	1 7/16in.	1 1/16in.	1in.	-	-	7/16in.	8-32 x 1in. (1)
10	+ 7883-1VB-P	128mm	Pull	5 1 1/16in.	5/16in.	1 1/4in.	5 5/16in.	-	5/16in.	8-32 x 1in. (2)
11	7901-1VB-P	3in.	Pull	3 3/16in.	3/16in.	1 1/4in.	-	-	3/16in.	8-32 x 1in. (2)
12	7876-1VB-P	3in.	Cup Pull	4 5/16in.	1 3/16in.	1in.	5 3/16in.	-	-	8-32 x 1in. (2)
13	7886-1VB-P	64mm	Cup Pull	4 1/16in.	1 1/16in.	1in.	7/16in.	-	-	8-32 x 1in. (2)
14	7878-1VB-P	-	Knob	1 3/16in.	7/16in.	1 1/4in.	-	-	5/16in.	8-32 x 1in. (1)
15	7899-1VB-P	-	Knob	-	-	1 1/16in.	-	1 1/16in.	3/4in.	8-32 x 1in. (1)

+2 Additional 8-32 x 1 3/4in. break-off screws provided.

VILLAGE

TIMELESS CHARM - *Traditional Style*

Collection Featured in Brushed Nickel



Appliance Pull
Also Available

Village Available Finishes, Sizes & Part Numbers

Handle Underside: Flat



BRUSHED NICKEL

256mm CC	2083-1BPN-P
160mm CC	2081-1BPN-P
128mm CC	2079-1BPN-P
96mm CC	2077-1BPN-P
3in. CC	2075-1BPN-P

VERONA BRONZE

256mm CC	2084-10VB-P
160mm CC	2082-10VB-P
128mm CC	2080-10VB-P
96mm CC	2078-10VB-P
3in. CC	2076-10VB-P

Village Product Data

Collection Material: Zinc

CC	Product Type	Length	Width	Height/ Projection	Hand Clearance	Diameter	Base	Tap/Screws (Qty)
*256mm	Appliance Pull	12 3/4in.	1 5/8in.	1 1/2in.	1 1/2in.	-	1 5/8in.	10-24 x 1in. (2)
160mm	Pull	8 1/2in.	5/8in.	1 1/2in.	2 5/32in.	-	1 3/8in.	8-32 x 1in. (2)
128mm	Pull	6 7/8in.	5/8in.	1 1/2in.	3/4in.	-	1 3/8in.	8-32 x 1in. (2)
96mm	Pull	5 3/4in.	5/8in.	1 1/2in.	1 1/8in.	-	1 3/8in.	8-32 x 1in. (2)
3in.	Pull	4 3/4in.	5/8in.	1 1/2in.	4 3/16in.	-	1 1/2in.	8-32 x 1in. (2)

*Product not shown, please visit BerensonHardware.com to view images and details.



An *uncomplicated* design with rounded ends make for a *soft* appearance.



ARTISAN *INSPIRED*

Craftsman Style

Craft an artistic & unique look by using distinct hardware designs that excite the eye.

Featuring the Rhapsody Collection in Black

ART NOUVEAU

ARTISAN INSPIRED - *Craftsman Style*

Collection Featured in Vintage Nickel

Scan the QR Code above for more details!



Art Nouveau Available Finishes, Sizes & Part Numbers

Handle Underside: Semi-Curved



VERONA BRONZE

128mm CC	4014-10VB-P
96mm CC	4011-10VB-P
3in. & 3 1/2in. CC	4134-10VB-P
Knob	4017-10VB-P



VINTAGE NICKEL

128mm CC	4015-1VTN-P
96mm CC	4012-1VTN-P
3in. & 3 1/2in. CC	4135-1VTN-P
Knob	4018-1VTN-P

Art Nouveau Product Data

Collection Material: Zinc

CC	Product Type	Length	Width	Height/Projection	Hand Clearance	Diameter	Base	Tap/Screws (Qty)
*128mm	Pull	7 1/4in.	1in.	1 3/4in.	1 7/8in.	-	1 3/4in.	8-32 x 1in. (2)
96mm	Pull	5 1/4in.	1 1/4in.	1 3/4in.	1 1/8in.	-	5/8in.	8-32 x 1in. (2)
3in. & 3 1/2in.	Pull	5 1/4in.	1 1/4in.	1 1/4in.	1 7/8in.	-	7/8in.	8-32 x 1in. (2)
-	Knob	-	-	1 1/4in.	5/8in.	1 3/8in.	7/8in.	8-32 x 1in. (1)

*The 128mm CC pull features a wider width that adds dimension to kitchen and bath designs.

RHAPSODY

ARTISAN INSPIRED - *Craftsman Style*

Collection Featured in Black

Scan the QR Code above for more details!



Rhapsody Available Finishes, Sizes & Part Numbers

Handle Underside: Curved



BLACK

128mm CC	3040-155-P
96mm CC	3043-155-P
① Knob	3046-155-P
② Knob	3049-155-P
③ Knob	3052-155-P
④ Knob	3055-155-P



WEATHERED IRON

128mm CC	3041-1LWI-P
96mm CC	3044-1LWI-P
① Knob	3047-1LWI-P
② Knob	3050-1LWI-P
③ Knob	3053-1LWI-P
④ Knob	Not Available



WEATHERED NICKEL

128mm CC	3042-1WN-P
96mm CC	3045-1WN-P
① Knob	3048-1WN-P
② Knob	3051-1WN-P
③ Knob	3054-1WN-P
④ Knob	3057-1WN-P

Rhapsody Product Data

Collection Material: Zinc

	CC	Product Type	Length	Width	Height/Projection	Hand Clearance	Diameter	Base	Tap/Screws (Qty)
1	-	Knob	2 1/2in.	1/2in.	1 1/4in.	2 1/2in.	-	7/8in.	8-32 x 1in. (1)
2	-	Knob	1 3/4in.	1 3/4in.	1 1/4in.	1 7/8in.	-	7/8in.	8-32 x 1in. (1)
3	-	Knob	-	-	1in.	2 3/4in.	1 5/8in.	7/8in.	8-32 x 1in. (1)
4	-	Knob	-	-	1 5/8in.	1/2in.	1 1/4in.	7/8in.	8-32 x 1in. (1)
5	128mm	Pull	5 7/8in.	3/4in.	1 1/4in.	5 5/8in.	-	7/8in.	8-32 x 1in. (2)
6	96mm	Pull	4 3/4in.	3/4in.	1 1/4in.	5 5/8in.	-	7/8in.	8-32 x 1in. (2)

Featuring the Subtle Surge Collection in Brushed Nickel
Design and photos by Jennifer Hutton at
Artisan Kitchens and Baths,
@JenniferHutton_Pro



CC & INSTALL

Guide for Berenson's Hardware

Scan the QR code for to visit our online conversion chart.
Quickly find hardware in the size you need!

DETERMINING CENTER TO CENTER

Our pulls come in a range of sizes and are measured in either inches or millimeters. To determine the center to center (CC) of a pull, use a ruler to measure the distance between the centers of the screw holes.

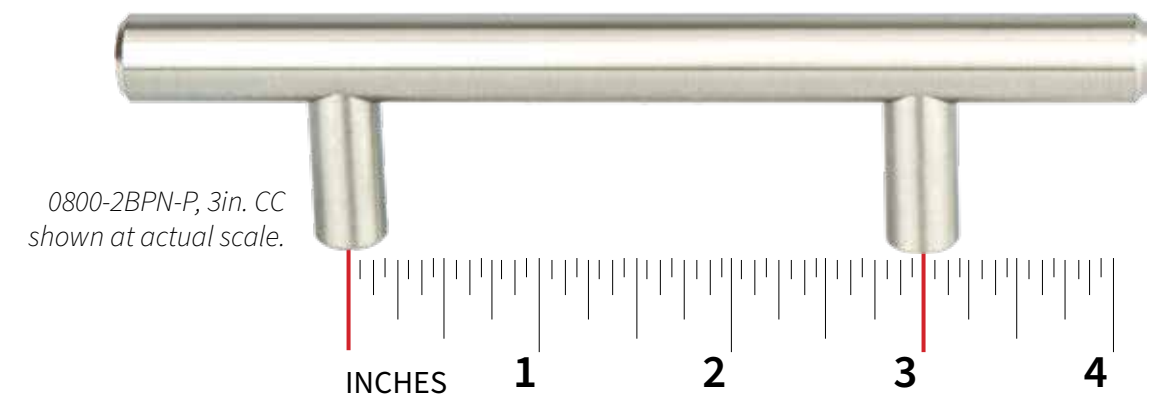

CC MEASUREMENT CONVERSION

Inches	Millimeters	Inches	Millimeters	Inches	Millimeters
1 1/4in.	32mm	6in.	152.4mm	15 1/2in.	384mm
2 3/8in.	56mm	6 5/8in.	160mm	16 3/8in.	416mm
2 1/2in.	64mm	6 7/8in.	169mm	17 1/2in.	448mm
3in.	76.2mm	7 1/4in.	192mm	18in.	457.2mm
3 1/2in.	88.9mm	8 1/8in.	224mm	21 1/2in.	544mm
3 7/8in.	96mm	10 1/8in.	256mm	25 7/8in.	640mm
4in.	101.6mm	11 1/4in.	288mm	26 3/4in.	672mm
4 1/2in.	112mm	12in.	304.8mm	30 7/8in.	768mm
5 1/8in.	128mm	12 1/2in.	320mm		

INSTALLING DECORATIVE HARDWARE FOR THE FIRST TIME

When you have decided where you want your hardware placed, use a ruler or cabinet hardware template to mark the drilling locations.

You'll want the placement to be the same across all cabinets for a consistent look. Once all the locations are marked you are ready to use your 3/16in. drill bit and drill the holes.

TOOLS REQUIRED:

- ① Ruler or Cabinet Hardware Template
- ② Power Drill

Where you place your hardware on a cabinet is entirely up to you. You can see some traditional placement of hardware to the right.

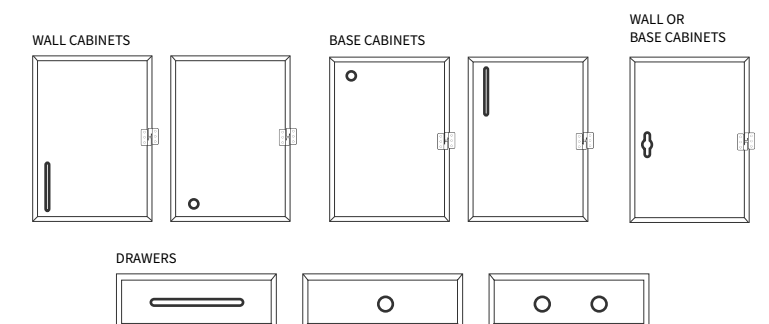



DISPLAY BOARDS

Learn About Our Merchandising Options

Customers can request the type of display board that's best for their business.

DISPLAY BOARD OPTIONS

We offer display boards with and without printed part numbers. You can tell which is which based on the part number for the board.

Display boards measure 11 1/16in. x 15 1/16in. x 1/8in.

-03 = NO PART NUMBERS

0292-7000-03-G • No part numbers printed on front

-05 = PART NUMBERS

0292-7000-05-G • Part numbers printed on front

PLANOGRAM STICKERS (POG)

Additional part information can be found on the Planogram (POG) sticker located on the back of Berenson and R. Christensen by Berenson display boards.

- Dots on the POG note the parts that are shown on the front of the board.

Info that can be found on the POG:

- CC Measurement
- Product Type
- Finish
- Part Number
- Price Code

ASPIRE-01			0292-7000-03-G		
CC	Type	Finish	Part No.	Price Code	
18 in.	App. Pull	Polished Chrome	2147-1026-P	E	
12 in.	App. Pull	Polished Chrome	9239-1026-P	E	
160 mm.	Pull	Polished Chrome	9236-1026-P	C	
128 mm.	Pull	Polished Chrome	9233-1026-P	C	
96 mm.	Pull	Polished Chrome	9230-1026-P	C	
•	Knob	Polished Chrome	9242-1026-P	A	
18 in.	App. Pull	Brushed Nickel	2148-1BPN-P	E	
12 in.	App. Pull	Brushed Nickel	9240-1BPN-P	E	
160 mm.	Pull	Brushed Nickel	9237-1BPN-P	C	
128 mm.	Pull	Brushed Nickel	9234-1BPN-P	C	
96 mm.	Pull	Brushed Nickel	9231-1BPN-P	C	
•	Knob	Brushed Nickel	9243-1BPN-P	A	
18 in.	App. Pull	Brushed Tin	2149-10BT-P	E	
•	12 in.	App. Pull	Brushed Tin	9241-10BT-P	E
•	160 mm.	Pull	Brushed Tin	9238-10BT-P	C
•	128 mm.	Pull	Brushed Tin	9235-10BT-P	C
•	96 mm.	Pull	Brushed Tin	9232-10BT-P	C
•	Knob	Brushed Tin	9244-10BT-P	A	
18 in.	App. Pull	Verona Bronze	2150-10VB-P	E	
12 in.	App. Pull	Verona Bronze	2032-10VB-P	E	
160 mm.	Pull	Verona Bronze	2031-10VB-P	C	
128 mm.	Pull	Verona Bronze	2030-10VB-P	C	
96 mm.	Pull	Verona Bronze	2029-10VB-P	C	
•	Knob	Verona Bronze	2033-10VB-P	A	

• Part shown on front of board. 0292-POG-01

DISPLAY BOARDS - CLASSIC COMFORT

Look for Updated Boards



Aspire - pg 19 0292-7000-05-G



Brookridge - pg 21 0541-7000-05-G



Euro Moderno - pg 35 0364-7000-05-G



Forté - pg 36 0241-7000-05-G



Connections - pg 23 0275-7000-05-G



Designers' Group Ten - pg 25 0280-7000-05-G



Meadow - pg 37 0370-7000-05-G



Oasis - pg 39 0293-7000-05-G



Dierdra - pg 29 0322-7000-05-G



Domestic Bliss - pg 33 0380-7000-05-G



Rivet Rebel - pg 43 0564-7000-05-G



Subtle Surge - pg 45 0478-7000-05-G

DISPLAY BOARDS - *CLASSIC COMFORT*



Tempo - pg 47

0377-7000-05-G

DISPLAY BOARDS - *UPTOWN APPEAL*

Look for Updated Boards



Bravo - pg 53

0270-7000-05-G



Elevate - pg 55

0369-7000-05-G

Featuring the Metro Collection in Matte Black Design and photos by Jennifer Hutton at Grau Design Studio, @JenniferHutton_Pro



Epoch Edge - pg 57

0479-7000-05-G



Fluidic - pg 59

0314-7000-05-G



Laura - pg 63

0323-7000-05-G



Metro - pg 67

0274-7000-05-G

DISPLAY BOARDS - *UPTOWN APPEAL*

Look for Updated Boards



Radial Reign - pg 71 0565-7000-05-G



Roque - pg 73 0578-7000-05-G



Skyline - pg 75 0291-7000-05-G



Stainless Steel - pg 77 0217-70SS-05-G



Studio - pg 78 0371-7000-05-G



Swagger - pg 79 0378-7000-05-G

DISPLAY BOARDS - *TIMELESS CHARM*



American Classics - pg 83 0214-7000-05-G



Andante | Euro Traditions - pg 85 & 89 0360-7000-05-G



Echo - pg 88 0295-7000-05-G



Harmony - pg 90 0313-7000-05-G



Hearthstone - pg 91 0277-7000-05-G



Hillcrest - pg 93 0373-7000-05-G

DISPLAY BOARDS - *TIMELESS CHARM*

Look for Updated Boards



Prelude - pg 94 0211-7000-05-G



Tailored Traditional - pg 97 0477-7000-05-G



Vested Interest - pg 99 0379-7000-05-G



Vibrato - pg 101 0204-70VB-05-G



Village - pg 103 0372-7000-05-G

DISPLAY BOARDS - *ARTISAN INSPIRED*



Art Nouveau - pg 107 0276-7000-05-G



Rhapsody - pg 108 0361-7000-05-G



Featuring the Hearthstone Collection in Matte Black

DISPLAY BOARDS – *FEATURED STYLES*



BEAUTY BOARDS

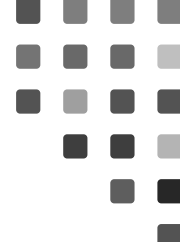

Black and Gold 0199-7000-05



Contemporary Best Sellers - pg 51 0567-7000-05



Cup Pulls & Knobs 0563-7000-05



Finish Selection - pg 15 0569-7000-05



Traditional Best Sellers - pg 81 0568-7000-05



Transitional Best Sellers - pg 17 0566-7000-05

BENEFITS

Beauty boards are a great way to fill in your display tower while also providing helpful tools and inspiration to customers.

The **Pricing Code** and **Samplicity** beauty boards connect customers to our website where they can access resources on our hardware pricing and sample program.

Product images draw attention and complement the hardware with striking imagery. They offer a unique visual and different look at our knobs and pulls.

Each beauty display board measures **11 13/16in. x 15 13/16in. x 1/8in.** and has a notch in the bottom to help insert and remove the board from the display.



PRICE CODE BEAUTY BOARD 0496-7000-02



SAMPLICITY BEAUTY BOARD 0585-7000-02

PLEASE NOTE:

Display board artwork is subject to change at any time and may not reflect the image shown above. Beauty Boards contain printed **IMAGES ONLY. NO HARDWARE INCLUDED** ON BEAUTY BOARDS.

Scan the QR code above to view our selection of beauty boards or contact **Sales@BerensonHardware.com** for more information.



DISPLAY TOWERS

Scan the QR Code to access the Tower Order Form.

Berenson offers two different size towers for displaying our products, a 12-board option and a 36-board option. Each display tower rotates 360 degrees for easy access and comes with branded headers. Choose a standard selection of display boards or build a custom tower.



12-BOARD TOWER

0012-2000-01

WHAT TO KNOW:

Measures 19 3/4in. width by 85 1/4in. height and holds 12 display boards.



36-BOARD TOWER

0011-2000-01

WHAT TO KNOW:

Measures 34 7/8in. width by 85 1/4in. height and holds 36 display boards.

DISPLAY ACCESSORIES

BRAND HEADERS

Brand headers are available in three options: Berenson, Advantage Plus by Berenson and R. Christensen by Berenson. Each header is double-sided and can also be placed back to back for dual branding. The 12-board display tower has one header slot and the 36-board display tower has three header slots.

Brand headers measure 7 7/8in. x 15 1/4in. x 1/2in.



Berenson Header
0512-7000-02



Advantage Plus Header
0513-7000-02



R. Christensen Header
0514-7000-02



DISPLAY TOWER SHELF
0170-OKIT-01

Attaches right onto the tower!

This kit includes the Display Tower Shelf, Display Board Guide, the Price Code Guide, and assembly instructions.

Additional Marketing Materials, such as this catalog or the Take Away Brochure, can also be stored in the shelf.

Visit our YouTube channel **@BerensonHardware** to watch a video on how to install the shelf to your tower!

For more information or to order contact:
Sales@BerensonHardware.com | 800.333.0578



FAQ

Additional Questions?

Check our FAQ section on our website, scan the QR Code above, or email us at Info@BerensonHardware.com

Featuring the Swagger Collection in Modern Brushed Gold Design and photos by Jennifer Hutton at Artisan Kitchens and Baths, @JenniferHutton_Pro

Where can I see and buy Berenson hardware on display?

You can purchase Berenson hardware from a variety of sources, including architectural hardware showrooms, kitchen and bath oriented dealers, and internet re-sellers.

To find the retailer nearest to you, visit our website Find a Store page. If you carry Berenson product and would like your business to be listed on our Find a Store page, please contact your sales representative or fill out the List My Store form.

Do you offer an online catalog?

Yes, you can view and download a digital copy of all of our current catalogs on our website, BerensonHardware.com. Locate them from our Main Menu under the Support section.

Is there a minimum order quantity?

There is no minimum order quantity or broken box charge. Berenson will ship any product in any quantity.

How soon are items shipped after being ordered?

Orders placed before 3:00 PM EST will ship the same day.

Large orders that must ship by truck will go out the day after the order is placed.

Do you offer drop shipments?

Yes, we will ship right to your customer if needed.

Do your products come with screws and what length are they?

Yes, most hardware includes 8-32 x 1in. machine screws or M4 x 45mm break off screws.

Appliance pulls come with 10-24 x 1in. machine screws.

Please see product data tables on collection pages to find out which type of screw comes with each part.

What is the best way to care for hardware?

Our decorative hardware is best cleaned with warm water, mild soap, and a soft cloth when necessary. Avoid the use of abrasive cleaning products or window cleaner. Over time, the use of such products will result in the removal of the protective coating.



Featuring the Brookridge Collection
in Brushed Nickel



KEY TO CODES

PART NUMBER BREAKDOWN

Parts Are Identified As Follows:

ITEM #: Four-digit item code
(followed by a dash)

MATERIAL: One-digit primary
material code

FINISH: Two-digit code or a character code
(two or three letters) to distinguish
the finish (followed by a dash)

PACKAGING: One-letter packaging code



EXAMPLE

Part Number:
2640-1BPN-P

ITEM # MATERIAL FINISH PACKAGING

*Description of Above Example:
Zinc Diecast, Brushed Nickel,
Polybagged w/Mounting Hardware*

KEY TO MATERIAL CODES

- 1 Zinc Diecast (Zamac)
- 2 Steel
- 4 Aluminum
- 9 Other (Stainless Steel or Crystal)

KEY TO FINISH CODES

See Pages 15-16 for Codes.

KEY TO PACKAGING CODES

- B** Item is supplied in bulk without mounting screws or escutcheon pins. (Mounting hardware ordered separately.)
- C** Item is supplied in a carton with 8-32 x 1in. or M4 x 45mm break off screws.
- P** Item is individually polybagged with 8-32 x 1in. screws or other mounting hardware.



PRICING BREAKDOWN

Scan the QR code for the most updated pricing brackets for codes A-E.

PART INDEX

Part No.	CC/Type	Page No.
0800-2BPN-P	3in.	47
0801-20VB-P	3in.	47
0802-2BPN-P	96mm	47
0803-20VB-P	96mm	47
0804-2BPN-P	128mm	47
0805-20VB-P	128mm	47
0806-2BPN-P	192mm	47
0807-20VB-P	192mm	47
0808-2BPN-P	256mm	47
0809-20VB-P	256mm	47
0810-2BPN-P	320mm	47
0811-20VB-P	320mm	47
0812-20VB-P	160mm	47
0813-20VB-P	224mm	47
0820-2MDB-P	3in.	47
0821-2MDB-P	96mm	47
0822-2MDB-P	128mm	47
0823-2MDB-P	160mm	47
0824-2MDB-P	192mm	47
0825-2MDB-P	224mm	47
0826-2MDB-P	256mm	47
0828-2MDB-P	320mm	47
0829-2MDB-P	Knob	47
0830-2055-P	3in.	47
0831-2055-P	96mm	47
0832-2055-P	128mm	47
0833-2055-P	160mm	47
0834-2055-P	192mm	47
0835-2055-P	224mm	47
0836-2055-P	256mm	47
0838-2055-P	320mm	47
0839-2055-P	Knob	47
1046-40BC-P	32mm	53
1047-40BC-P	56mm	53
1048-40BC-P	112mm	53
1049-40BC-P	169mm	53

Part No.	CC/Type	Page No.
1051-4ALU-B	Edge Pull	53
1052-4BPN-P	32mm	53
1053-4026-P	32mm	53
1055-40VB-P	32mm	53
1056-4055-P	32mm	53
1057-4BPN-P	56mm	53
1058-4026-P	56mm	53
1059-40VB-P	56mm	53
1060-4055-P	56mm	53
1061-4BPN-P	112mm	53
1062-4026-P	112mm	53
1063-40VB-P	112mm	53
1064-4055-P	112mm	53
1065-4BPN-P	169mm	53
1066-4026-P	169mm	53
1067-40VB-P	169mm	53
1068-4055-P	169mm	53
1069-40SG-P	32mm	53
1070-40SG-P	56mm	53
1071-40SG-P	112mm	53
1072-40SG-P	169mm	53
1073-4GPH-P	32mm	53
1074-4GPH-P	56mm	53
1075-4GPH-P	112mm	53
1076-4GPH-P	169mm	53
1114-1MDB-P	18in.	45
1115-1BPN-P	18in.	45
1116-1014-P	18in.	45
1117-10VB-P	18in.	45
1118-1VTN-P	18in.	45
1119-1055-P	18in.	45
1120-1026-P	320mm	75
1121-1SLT-P	3in. & 96mm	75
1122-1SLT-P	160mm	75
1123-1SLT-P	224mm	75
1124-1SLT-P	320mm	75

Part No.	CC/Type	Page No.
1125-1SLT-P	Knob	75
1126-2BPN-P	160mm	47
1127-2BPN-P	224mm	47
1128-2BPN-P	288mm	49
1129-2BPN-P	384mm	49
1130-2BPN-P	448mm	49
1131-2BPN-P	544mm	49
1132-2BPN-P	640mm	49
1133-2BPN-P	768mm	49
1200-1BPN-P	Knob	57
1201-10VB-P	Knob	57
1202-1026-P	Knob	57
1203-1055-P	Knob	57
1204-1MDB-P	Knob	57
1205-1VTN-P	Knob	57
1206-1BPN-P	96mm	57
1207-10VB-P	96mm	57
1208-1026-P	96mm	57
1209-1055-P	96mm	57
1210-1MDB-P	96mm	57
1211-1VTN-P	96mm	57
1212-1BPN-P	128mm	57
1213-10VB-P	128mm	57
1214-1026-P	128mm	57
1215-1055-P	128mm	57
1216-1MDB-P	128mm	57
1217-1VTN-P	128mm	57
1218-1BPN-P	160mm	57
1219-10VB-P	160mm	57
1220-1026-P	160mm	57
1221-1055-P	160mm	57
1222-1MDB-P	160mm	57
1223-1VTN-P	160mm	57
1224-1BPN-P	224mm	57
1225-10VB-P	224mm	57
1226-1026-P	224mm	57

Part No.	CC/Type	Page No.
1227-1055-P	224mm	57
1228-1MDB-P	224mm	57
1229-1VTN-P	224mm	57
1230-1BPN-P	12in.	57
1231-10VB-P	12in.	57
1232-1026-P	12in.	57
1233-1055-P	12in.	57
1234-1MDB-P	12in.	57
1235-1VTN-P	12in.	57
1236-1BPN-P	Knob	45
1237-10VB-P	Knob	45
1238-1014-P	Knob	45
1239-1055-P	Knob	45
1240-1MDB-P	Knob	45
1241-1VTN-P	Knob	45
1242-1BPN-P	96mm	45
1243-10VB-P	96mm	45
1244-1014-P	96mm	45
1245-1055-P	96mm	45
1246-1MDB-P	96mm	45
1247-1VTN-P	96mm	45
1248-1BPN-P	128mm	45
1249-10VB-P	128mm	45
1250-1014-P	128mm	45
1251-1055-P	128mm	45
1252-1MDB-P	128mm	45
1253-1VTN-P	128mm	45
1254-1BPN-P	160mm	45
1255-10VB-P	160mm	45
1256-1014-P	160mm	45
1257-1055-P	160mm	45
1258-1MDB-P	160mm	45
1259-1VTN-P	160mm	45
1260-1BPN-P	224mm	45
1261-10VB-P	224mm	45
1262-1014-P	224mm	45
1263-1055-P	224mm	45
1264-1MDB-P	224mm	45
1265-1VTN-P	224mm	45

Part No.	CC/Type	Page No.
1266-1BPN-P	12in.	45
1267-10VB-P	12in.	45
1268-1014-P	12in.	45
1269-1055-P	12in.	45
1270-1MDB-P	12in.	45
1271-1VTN-P	12in.	45
1272-1BPN-P	Knob	97
1273-10VB-P	Knob	97
1274-1014-P	Knob	97
1275-1055-P	Knob	97
1276-1MDB-P	Knob	97
1277-1VTN-P	Knob	97
1278-1BPN-P	96mm	97
1279-10VB-P	96mm	97
1280-1014-P	96mm	97
1281-1055-P	96mm	97
1282-1MDB-P	96mm	97
1283-1VTN-P	96mm	97
1284-1BPN-P	128mm	97
1285-10VB-P	128mm	97
1286-1014-P	128mm	97
1287-1055-P	128mm	97
1288-1MDB-P	128mm	97
1289-1VTN-P	128mm	97
1290-1BPN-P	160mm	97
1291-10VB-P	160mm	97
1292-1014-P	160mm	97
1293-1055-P	160mm	97
1294-1MDB-P	160mm	97
1295-1VTN-P	160mm	97
1296-1BPN-P	224mm	97
1297-10VB-P	224mm	97
1298-1014-P	224mm	97
1299-1055-P	224mm	97
1300-1MDB-P	224mm	97
1301-1VTN-P	224mm	97
1302-1BPN-P	12in.	97
1303-10VB-P	12in.	97
1304-1014-P	12in.	97

Part No.	CC/Type	Page No.
1305-1055-P	12in.	97
1306-1MDB-P	12in.	97
1307-1VTN-P	12in.	97
2006-2026-P	320mm	47
2012-2026-P	3in.	47
2013-2026-P	96mm	47
2014-2026-P	128mm	47
2015-2026-P	192mm	47
2016-2026-P	224mm	47
2017-2026-P	256mm	47
2018-20VB-P	Knob	47
2019-2026-P	Knob	47
2020-2BPN-P	Knob	47
2021-90SS-P	128mm	78
2022-90SS-P	160mm	78
2023-90SS-P	192mm	78
2024-90SS-P	224mm	78
2025-90SS-P	256mm	78
2026-90SS-P	288mm	78
2027-90SS-P	576mm	78
2028-2026-P	160mm	47
2029-10VB-P	96mm	19
2030-10VB-P	128mm	19
2031-10VB-P	160mm	19
2032-10VB-P	12in.	19
2033-10VB-P	Knob	19
2034-10VB-P	12in.	91
2035-1BPN-P	12in.	91
2036-1014-P	12in.	25
2037-1WVB-P	12in.	91
2038-1055-P	12in.	91
2039-10VB-P	128mm	91
2040-1BPN-P	128mm	91
2041-1014-P	128mm	25
2042-1WVB-P	128mm	91
2043-1055-P	128mm	91
2044-10VB-P	160mm	91
2045-1BPN-P	160mm	91
2046-1014-P	160mm	25

Part No.	CC/Type	Page No.
2047-1WVB-P	160mm	91
2048-1055-P	160mm	91
2049-1BPN-P	96mm	93
2055-1FE-P	Knob	83
2068-10VB-P	96mm	93
2069-1BPN-P	128mm	93
2070-10VB-P	128mm	93
2071-1BPN-P	160mm	93
2072-10VB-P	160mm	93
2073-1BPN-P	256mm	93
2074-10VB-P	256mm	93
2075-1BPN-P	3in.	103
2076-10VB-P	3in.	103
2077-1BPN-P	96mm	103
2078-10VB-P	96mm	103
2079-1BPN-P	128mm	103
2080-10VB-P	128mm	103
2081-1BPN-P	160mm	103
2082-10VB-P	160mm	103
2083-1BPN-P	256mm	103
2084-10VB-P	256mm	103
2085-4BPN-P	96mm	55
2086-40VB-P	96mm	55
2087-4BPN-P	128mm	55
2088-40VB-P	128mm	55
2089-4BPN-P	160mm	55
2090-40VB-P	160mm	55
2091-4BPN-P	256mm	55
2092-40VB-P	256mm	55
2093-4BPN-P	320mm	55
2094-40VB-P	320mm	55
2095-4BPN-P	Knob	55
2096-40VB-P	Knob	55
2097-4BPN-P	96mm	37
2098-40VB-P	96mm	37
2099-4BPN-P	128mm	37
2100-40VB-P	18in.	55
2101-4BPN-P	18in.	55

Part No.	CC/Type	Page No.
2102-40SG-P	96mm	55
2103-40SG-P	128mm	55
2104-40SG-P	160mm	55
2105-40SG-P	256mm	55
2106-40SG-P	320mm	55
2107-40SG-P	18in.	55
2108-40SG-P	Knob	55
2109-4GPH-P	96mm	55
2110-4GPH-P	128mm	55
2111-4GPH-P	160mm	55
2112-4GPH-P	256mm	55
2113-4GPH-P	320mm	55
2114-4GPH-P	18in.	55
2115-4GPH-P	Knob	55
2116-4055-P	96mm	55
2117-4055-P	128mm	55
2118-4055-P	160mm	55
2119-4055-P	256mm	55
2120-4055-P	320mm	55
2121-4055-P	18in.	55
2122-4055-P	Knob	55
2123-4026-P	96mm	55
2124-4026-P	128mm	55
2125-4026-P	160mm	55
2126-4026-P	256mm	55
2127-4026-P	320mm	55
2128-4026-P	18in.	55
2129-4026-P	Knob	55
2130-1MDB-P	96mm	19
2131-1MDB-P	128mm	19
2132-1MDB-P	160mm	19
2133-1MDB-P	12in.	19
2134-1MDB-P	18in.	19
2135-1MDB-P	Knob	19
2136-1055-P	96mm	19
2137-1055-P	128mm	19
2138-1055-P	160mm	19
2139-1055-P	12in.	19

Part No.	CC/Type	Page No.
2140-1055-P	18in.	19
2141-1055-P	Knob	19
2142-10BC-P	96mm	19
2143-10BC-P	128mm	19
2144-10BC-P	160mm	19
2145-10BC-P	12in.	19
2146-10BC-P	Knob	19
2147-1026-P	18in.	19
2148-1BPN-P	18in.	19
2149-10BT-P	18in.	19
2150-10VB-P	18in.	19
2151-1MDB-P	3in.	91
2152-1MDB-P	96mm	91
2153-1MDB-P	128mm	91
2154-1MDB-P	160mm	91
2155-1MDB-P	6in.	91
2156-1MDB-P	12in.	91
2157-1MDB-P	18in.	91
2158-1MDB-P	Knob	91
2159-1VTN-P	3in.	91
2160-1VTN-P	96mm	91
2161-1VTN-P	128mm	91
2162-1VTN-P	160mm	91
2163-1VTN-P	6in.	91
2164-1VTN-P	12in.	91
2165-1VTN-P	18in.	91
2166-1VTN-P	Knob	91
2167-10VB-P	18in.	91
2168-1BPN-P	18in.	91
2169-1055-P	18in.	91
2172-1BPN-P	Knob	55
2173-10SG-P	Knob	55
2174-1GPH-P	Knob	55
2175-1055-P	Knob	55
2176-1026-P	Knob	55
2177-10VB-P	Knob	55
2273-40SG-P	96mm	37
2274-40SG-P	128mm	37

Part No.	CC/Type	Page No.
2275-40SG-P	160mm	37
2276-40SG-P	256mm	37
2277-40SG-P	320mm	37
2278-40SG-P	448mm	37
2279-40SG-P	Knob	37
2280-4GPH-P	96mm	37
2281-4GPH-P	128mm	37
2282-4GPH-P	160mm	37
2283-4GPH-P	256mm	37
2284-4GPH-P	320mm	37
2285-4GPH-P	448mm	37
2286-4GPH-P	Knob	37
2287-4055-P	96mm	37
2288-4055-P	128mm	37
2289-4055-P	160mm	37
2290-4055-P	256mm	37
2291-4055-P	320mm	37
2292-4055-P	448mm	37
2293-4055-P	Knob	37
2294-4026-P	96mm	37
2295-4026-P	128mm	37
2296-4026-P	160mm	37
2297-4026-P	256mm	37
2298-4026-P	320mm	37
2299-4026-P	448mm	37
2300-4026-P	Knob	37
2301-40VB-P	448mm	37
2302-4BPN-P	448mm	37
2303-40VB-P	128mm	37
2304-4BPN-P	160mm	37
2305-40VB-P	160mm	37
2306-4BPN-P	256mm	37
2307-40VB-P	256mm	37
2308-4BPN-P	320mm	37
2309-40VB-P	320mm	37
2310-1BPN-P	Knob	37
2311-10VB-P	Knob	37
2312-1BPN-P	128mm	79

Part No.	CC/Type	Page No.
2313-1026-P	128mm	79
2314-1098-P	128mm	79
2315-1BPN-P	160mm	79
2316-1026-P	160mm	79
2317-1098-P	160mm	79
2318-1BPN-P	224mm	79
2319-1026-P	224mm	79
2320-1098-P	224mm	79
2321-1BPN-P	320mm	79
2322-1026-P	320mm	79
2323-1098-P	320mm	79
2324-1BPN-P	Knob	79
2325-1026-P	Knob	79
2326-1098-P	Knob	79
2327-1BPN-P	96mm	99
2328-10VB-P	96mm	99
2329-1BPN-P	128mm	99
2330-10VB-P	128mm	99
2331-1BPN-P	160mm	99
2332-10VB-P	160mm	99
2333-1BPN-P	224mm	99
2334-10VB-P	224mm	99
2335-1BPN-P	12in.	99
2336-10VB-P	12in.	99
2337-1BPN-P	Knob	99
2338-10VB-P	Knob	99
2339-1BPN-P	96mm	33
2340-10VB-P	96mm	33
2341-1014-P	96mm	33
2342-1MDB-P	96mm	33
2343-1BPN-P	128mm	33
2344-10VB-P	128mm	33
2346-1014-P	128mm	33
2347-1MDB-P	128mm	33
2348-1BPN-P	160mm	33
2349-10VB-P	160mm	33
2350-1014-P	160mm	33
2351-1MDB-P	160mm	33

Part No.	CC/Type	Page No.
2352-1BPN-P	224mm	33
2353-10VB-P	224mm	33
2354-1014-P	224mm	33
2355-1MDB-P	224mm	33
2356-1BPN-P	320mm	33
2357-10VB-P	320mm	33
2358-1014-P	320mm	33
2359-1MDB-P	320mm	33
2360-1BPN-P	Knob	33
2361-10VB-P	Knob	33
2362-1014-P	Knob	33
2363-1MDB-P	Knob	33
2364-1MDB-P	128mm	79
2365-1MDB-P	160mm	79
2366-1MDB-P	224mm	79
2367-1MDB-P	320mm	79
2368-1MDB-P	Knob	79
2369-1VTN-P	96mm	99
2370-1VTN-P	128mm	99
2371-1VTN-P	160mm	99
2372-1VTN-P	224mm	99
2373-1VTN-P	12in.	99
2374-1VTN-P	Knob	99
2385-1098-P	96mm	79
2386-1BPN-P	96mm	79
2387-1MDB-P	96mm	79
2388-1026-P	96mm	79
2389-1SLT-P	Knob	79
2390-1SLT-P	96mm	79
2391-1SLT-P	128mm	79
2392-1SLT-P	160mm	79
2393-1SLT-P	224mm	79
2394-1055-P	Knob	79
2395-1055-P	96mm	79
2396-1055-P	128mm	79
2397-1055-P	160mm	79
2398-1055-P	224mm	79
2399-1055-P	Knob	33

Part No.	CC/Type	Page No.
2400-1055-P	96mm	33
2401-1055-P	128mm	33
2402-1055-P	160mm	33
2403-1SLT-P	Knob	33
2404-1SLT-P	96mm	33
2405-1SLT-P	128mm	33
2406-1SLT-P	160mm	33
2407-1SLT-P	224mm	33
2408-1055-P	320mm	33
2409-1055-P	224mm	33
2410-1055-P	320mm	33
2411-1055-P	320mm	79
2412-1SLT-P	320mm	79
2413-1BPN-P	18in.	79
2415-1MDB-P	18in.	79
2416-1098-P	18in.	79
2417-1055-P	18in.	79
2419-1BPN-P	18in.	33
2420-1055-P	18in.	33
2421-1MDB-P	18in.	33
2615-1BPN-P	96mm	21
2616-1055-P	96mm	21
2617-10VB-P	96mm	21
2619-MDB-P	96mm	21
2620-1BPN-P	128mm	21
2621-1055-P	128mm	21
2622-10VB-P	128mm	21
2624-1MDB-P	128mm	21
2625-1BPN-P	160mm	21
2626-1055-P	160mm	21
2627-10VB-P	160mm	21
2629-1MDB-P	160mm	21
2630-1BPN-P	224mm	21
2631-1055-P	224mm	21
2632-10VB-P	224mm	21
2634-1MDB-P	224mm	21
2635-1BPN-P	12in.	21
2636-1055-P	12in.	21

Part No.	CC/Type	Page No.
2637-10VB-P	12in.	21
2639-1MDB-P	12in.	21
2640-1BPN-P	Knob	21
2641-1055-P	Knob	21
2642-10VB-P	Knob	21
2644-1MDB-P	Knob	21
2645-1BPN-P	Knob	21
2646-1055-P	Knob	21
2647-10VB-P	Knob	21
2649-1MDB-P	Knob	21
2650-1026-P	96mm	21
2651-1026-P	128mm	21
2652-1026-P	160mm	21
2653-1026-P	224mm	21
2654-1026-P	12in.	21
2655-1026-P	Knob	21
2656-1026-P	Knob	21
2657-1BPN-P	18in.	21
2658-1055-P	18in.	21
2659-1MDB-P	18in.	21
2920-1BPN-P	Knob	89
2921-1BBN-P	Knob	89
2923-1BAC-P	Knob	89
2924-1BAP-P	Knob	89
2927-155-P	Knob	89
2928-1FE-P	Knob	89
2930-1BPN-P	96mm	89
2931-1BBN-P	96mm	89
2933-1BAC-P	96mm	89
2934-1BAP-P	96mm	89
2937-155-P	96mm	89
2938-1FE-P	96mm	89
3008-1DBZ-P	128mm	85
3009-1DBZ-P	64mm	85
3011-1AP-P	128mm	85
3012-1AP-P	64mm	85
3014-1BPN-P	96mm	85
3040-155-P	128mm	108

Part No.	CC/Type	Page No.
3041-1LWI-P	128mm	108
3042-1WN-P	128mm	108
3043-155-P	96mm	108
3044-1LWI-P	96mm	108
3045-1WN-P	96mm	108
3046-155-P	Knob	108
3047-1LWI-P	Knob	108
3048-1WN-P	Knob	108
3049-155-P	Knob	108
3050-1LWI-P	Knob	108
3051-1WN-P	Knob	108
3052-155-P	Knob	108
3053-1LWI-P	Knob	108
3054-1WN-P	Knob	108
3055-155-P	Knob	108
3057-1WN-P	Knob	108
4001-1VTN-P	3in.	23
4002-1055-P	3in.	23
4003-10VB-P	3in.	23
4004-1VTN-P	160mm	23
4005-1055-P	160mm	23
4006-10VB-P	160mm	23
4007-1VTN-P	Knob	23
4008-1055-P	Knob	23
4009-10VB-P	Knob	23
4011-10VB-P	96mm	107
4012-1VTN-P	96mm	107
4014-10VB-P	128mm	107
4015-1VTN-P	128mm	107
4017-10VB-P	Knob	107
4018-1VTN-P	Knob	107
4056-1BPN-P	96mm	29
4057-10VB-P	96mm	29
4058-10WN-P	96mm	29
4060-1ORB-P	96mm	29
4061-1BPN-P	Knob	29
4062-10VB-P	Knob	29
4063-10VB-P	3in.	91

Part No.	CC/Type	Page No.
4064-1BPN-P	3in.	91
4065-10WN-P	Knob	29
4067-1WVB-P	3in.	91
4068-1055-P	3in.	91
4069-10VB-P	96mm	91
4070-1BPN-P	96mm	91
4071-1ORB-P	Knob	29
4072-1BPN-P	96mm	63
4073-1WVB-P	96mm	91
4074-1055-P	96mm	91
4075-10VB-P	6in.	91
4076-1BPN-P	6in.	91
4079-1BPN-P	128mm	63
4079-1WVB-P	6in.	91
4080-1055-P	6in.	91
4081-10VB-P	Knob	91
4083-1BPN-P	Knob	91
4084-1026-P	96mm	63
4085-1WVB-P	Knob	91
4086-1055-P	Knob	91
4087-1026-P	128mm	63
4088-1BPN-P	Knob	63
4090-1026-P	Knob	63
4107-1014-P	96mm	29
4108-1BPN-P	96mm	67
4109-1026-P	96mm	67
4110-1014-P	Knob	29
4111-1055-P	96mm	67
4113-1BPN-P	128mm	67
4114-1026-P	128mm	67
4116-1055-P	128mm	67
4118-1BPN-P	160mm	67
4119-1026-P	160mm	67
4121-1055-P	160mm	67
4122-1BPN-P	Knob	67
4124-1026-P	Knob	67
4126-1055-P	Knob	67
4130-1VTN-P	96mm	23

Part No.	CC/Type	Page No.
4131-1055-P	96mm	23
4132-10VB-P	96mm	23
4134-10VB-P	3in. & 3½in.	107
4135-1VTN-P	3in. & 3½in.	107
4139-1014-P	3in.	25
4140-1014-P	96mm	25
4141-1014-P	6in.	25
4142-1014-P	Knob	25
4143-1014-P	Knob	25
4144-1014-P	96mm	25
4145-1014-P	Knob	25
4146-1014-P	3in.	25
4147-1014-P	4in.	25
4148-1014-P	3in.	25
4149-1014-P	6in.	25
4150-1014-P	Knob	25
4152-1014-P	Knob	25
4153-1014-P	96mm	25
4154-1014-P	18in.	25
4157-1055-P	96mm	29
4158-1055-P	Knob	29
4160-1MDB-P	96mm	29
4162-1MDB-P	Knob	29
4163-1MDB-P	128mm	29
4164-1MDB-P	160mm	29
4165-1MDB-P	224mm	29
4166-1MDB-P	12in.	29
4167-1055-P	128mm	29
4168-1055-P	160mm	29
4169-1055-P	224mm	29
4172-1055-P	12in.	29
4180-10PC-P	96mm	67
4181-10PC-P	128mm	67
4182-10PC-P	160mm	67
4183-10PC-P	224mm	67
4184-10PC-P	320mm	67
4185-10PC-P	Knob	67
4187-10TB-P	128mm	67

Part No.	CC/Type	Page No.
4188-10TB-P	160mm	67
4189-10TB-P	224mm	67
4190-10TB-P	320mm	67
4191-10TB-P	96mm	67
4192-10TB-P	Knob	67
4193-1BPN-P	12in.	63
4194-1MDB-P	12in.	63
4195-1026-P	12in.	63
4196-1VTN-P	12in.	63
4207-1055-P	Knob	63
4208-1055-P	96mm	63
4209-1055-P	128mm	63
4210-1055-P	160mm	63
4211-1055-P	224mm	63
4212-1055-P	12in.	63
4213-10TB-P	Knob	29
4214-10TB-P	96mm	29
4215-10TB-P	128mm	29
4216-10TB-P	160mm	29
4217-10TB-P	224mm	29
4218-10TB-P	12in.	29
5024-4BPN-P	Knob	71
5025-4BPN-P	96mm	71
5026-4BPN-P	128mm	71
5027-4BPN-P	160mm	71
5028-4BPN-P	224mm	71
5029-4BPN-P	12in.	71
5030-4026-P	Knob	71
5031-4026-P	96mm	71
5032-4026-P	128mm	71
5033-4026-P	160mm	71
5034-4026-P	224mm	71
5035-4026-P	12in.	71
5036-4055-P	Knob	71
5037-4055-P	96mm	71
5038-4055-P	128mm	71
5039-4055-P	160mm	71
5040-4055-P	224mm	71

Part No.	CC/Type	Page No.
5041-4055-P	12in.	71
5042-4SLT-P	Knob	71
5043-4SLT-P	96mm	71
5044-4SLT-P	128mm	71
5045-4SLT-P	160mm	71
5046-4SLT-P	224mm	71
5047-4SLT-P	12in.	71
5048-4MDB-P	Knob	71
5049-4MDB-P	96mm	71
5050-4MDB-P	128mm	71
5051-4MDB-P	160mm	71
5052-4MDB-P	224mm	71
5053-4MDB-P	12in.	71
5054-455MDB-P	Knob	71
5055-455MDB-P	96mm	71
5056-455MDB-P	128mm	71
5057-455MDB-P	160mm	71
5058-455MDB-P	224mm	71
5059-455MDB-P	12in.	71
5060-455BPN-P	Knob	71
5061-455BPN-P	96mm	71
5062-455BPN-P	128mm	71
5063-455BPN-P	160mm	71
5064-455BPN-P	224mm	71
5065-455BPN-P	12in.	71
5066-4BPN55-P	Knob	71
5067-4BPN55-P	96mm	71
5068-4BPN55-P	128mm	71
5069-4BPN55-P	160mm	71
5070-4BPN55-P	224mm	71
5071-4BPN55-P	12in.	71
5072-4098-P	Knob	71
5073-4098-P	96mm	71
5074-4098-P	128mm	71
5075-4098-P	160mm	71
5076-4098-P	224mm	71
5077-4098-P	12in.	71
5078-4BPN-P	Knob	43

Part No.	CC/Type	Page No.
5079-4BPN-P	96mm	43
5080-4BPN-P	128mm	43
5081-4BPN-P	160mm	43
5082-4BPN-P	224mm	43
5083-4BPN-P	12in.	43
5084-4026-P	Knob	43
5085-4026-P	96mm	43
5086-4026-P	128mm	43
5087-4026-P	160mm	43
5088-4026-P	224mm	43
5089-4026-P	12in.	43
5090-4055-P	Knob	43
5091-4055-P	96mm	43
5092-4055-P	128mm	43
5093-4055-P	160mm	43
5094-4055-P	224mm	43
5095-4055-P	12in.	43
5096-4SLT-P	Knob	43
5097-4SLT-P	96mm	43
5098-4SLT-P	128mm	43
5099-4SLT-P	160mm	43
5100-4SLT-P	224mm	43
5101-4SLT-P	12in.	43
5102-4MDB-P	Knob	43
5103-4MDB-P	96mm	43
5104-4MDB-P	128mm	43
5105-4MDB-P	160mm	43
5106-4MDB-P	224mm	43
5107-4MDB-P	12in.	43
5108-455MDB-P	Knob	43
5109-455MDB-P	96mm	43
5110-455MDB-P	128mm	43
5111-455MDB-P	160mm	43
5112-455MDB-P	224mm	43
5113-455MDB-P	12in.	43
5114-455BPN-P	Knob	43
5115-455BPN-P	96mm	43
5116-455BPN-P	128mm	43

Part No.	CC/Type	Page No.
5117-455BPN-P	160mm	43
5118-455BPN-P	224mm	43
5119-455BPN-P	12in.	43
5120-4BPN55-P	Knob	43
5121-4BPN55-P	96mm	43
5122-4BPN55-P	128mm	43
5123-4BPN55-P	160mm	43
5124-4BPN55-P	224mm	43
5125-4BPN55-P	12in.	43
5126-4SLT55-P	Knob	43
5127-4SLT55-P	96mm	43
5128-4SLT55-P	128mm	43
5129-4SLT55-P	160mm	43
5130-4SLT55-P	224mm	43
5131-4SLT55-P	12in.	43
5132-455MDB-P	18in.	43
5133-4BPN-P	18in.	43
5134-4055-P	18in.	43
5135-4MDB-P	18in.	43
5136-4BPN-P	18in.	71
5137-4055-P	18in.	71
5138-455MDB-P	18in.	71
5139-4MDB-P	18in.	71
5140-455BPN-P	18in.	71
7067-9SS-C	672mm	77
7068-9SS-C	128mm	77
7069-9SS-C	160mm	77
7070-9SS-C	224mm	77
7071-9SS-C	288mm	77
7072-9SS-C	384mm	77
7073-9SS-C	448mm	77
7074-9SS-C	96mm	77
7075-9SS-C	96mm	77
7076-9SS-C	128mm	77
7077-9SS-C	288mm	77
7078-9SS-C	Knob	77
7079-9SS-C	Knob	77
7876-1VB-P	3in.	101

Part No.	CC/Type	Page No.
7878-1VB-P	Knob	101
7881-1BPN-P	128mm	85
7883-1VB-P	128mm	101
7884-1BPN-P	64mm	85
7886-1VB-P	64mm	101
7888-1AP-P	96mm	85
7889-1DBZ-P	96mm	85
7890-1VB-P	96mm	101
7891-1BPN-P	Knob	85
7893-1AP-P	Knob	85
7894-1DBZ-P	Knob	85
7895-1VB-P	Knob	101
7897-1VB-P	Knob	101
7898-1VB-P	3in.	101
7899-1VB-P	Knob	101
7900-1VB-P	3in.	101
7901-1VB-P	3in.	101
7904-1VB-P	128mm	101
7905-1VB-P	96mm	101
7906-1VB-P	Knob	101
8011-26-P	Hook	94
8012-BPN-P	Hook	94
8013-WN-P	Hook	94
8014-55-P	Hook	94
8015-ORB-P	Hook	94
8016-VB-P	Hook	94
8018-MDB-P	Hook	94
8019-VTN-P	Hook	94
8090-1055-P	Knob	73
8091-1055-P	96mm	73
8092-1055-P	128mm	73
8093-1055-P	160mm	73
8094-1055-P	224mm	73
8095-1055-P	12in.	73
8096-1BPN-P	Knob	73
8097-1BPN-P	96mm	73
8098-1BPN-P	128mm	73
8099-1BPN-P	160mm	73

Part No.	CC/Type	Page No.
8100-1BPN-P	224mm	73
8101-1BPN-P	12in.	73
8102-1MDB-P	Knob	73
8103-1MDB-P	96mm	73
8104-1MDB-P	128mm	73
8105-1MDB-P	160mm	73
8106-1MDB-P	224mm	73
8107-1MDB-P	12in.	73
8108-1VTN-P	Knob	73
8109-1VTN-P	96mm	73
8110-1VTN-P	128mm	73
8111-1VTN-P	160mm	73
8112-1VTN-P	224mm	73
8113-1VTN-P	12in.	73
8114-1026-P	Knob	73
8115-1026-P	96mm	73
8116-1026-P	128mm	73
8117-1026-P	160mm	73
8118-1026-P	224mm	73
8119-1026-P	12in.	73
8120-1098-P	Knob	73
8121-1098-P	96mm	73
8122-1098-P	128mm	73
8123-1098-P	160mm	73
8124-1098-P	224mm	73
8125-1098-P	12in.	73
8267-1BPN-P	6in.	36
8268-1VB-P	6in.	36
8269-1ORB-P	6in.	36
8270-1WN-P	6in.	36
8273-1BPN-P	4in.	36
8274-1VB-P	4in.	36
8276-1WN-P	4in.	36
8279-1BPN-P	Knob	36
8280-1VB-P	Knob	36
8281-1ORB-P	Knob	36
8282-1WN-P	Knob	36
8285-1BPN-P	Knob	36

Part No.	CC/Type	Page No.
8286-1VB-P	Knob	36
8287-1ORB-P	Knob	36
8288-1WN-P	Knob	36
8297-1BPN-P	18in.	36
8298-1VB-P	18in.	36
8299-1ORB-P	18in.	36
8300-1WN-P	18in.	36
9079-1BPN-P	Knob	83
9200-1BPN-P	3in. & 96mm	75
9201-1026-P	3in. & 96mm	75
9202-1055-P	3in. & 96mm	75
9203-1BPN-P	160mm	75
9204-1026-P	160mm	75
9205-1055-P	160mm	75
9206-1BPN-P	224mm	75
9207-1026-P	224mm	75
9208-1055-P	224mm	75
9209-1BPN-P	Knob	75
9210-1026-P	Knob	75
9211-1055-P	Knob	75
9221-1ORB-P	3in.	88
9222-1BPN-P	3in.	88
9223-10VB-P	3in.	88
9224-1ORB-P	96mm	88
9225-1BPN-P	96mm	88
9226-10VB-P	96mm	88
9227-1ORB-P	Knob	88
9228-1BPN-P	Knob	88
9229-10VB-P	Knob	88
9230-1026-P	96mm	19
9231-1BPN-P	96mm	19
9232-10BT-P	96mm	19
9233-1026-P	128mm	19
9234-1BPN-P	128mm	19
9235-10BT-P	128mm	19
9236-1026-P	160mm	19
9237-1BPN-P	160mm	19
9238-10BT-P	160mm	19



2495 Main Street, Suite 111 Buffalo, NY 14214-2152
Phone: 800.333.0578 | Fax: 716.833.2402
Email: Info@BerensonHardware.com
BerensonHardware.com

© 2024 Berenson Corp

24.02
0515-MARK-01

FOLLOW US ON SOCIAL MEDIA!



Scan the QR code for easy access to our social media pages.

